



Power supply  
system for  
work spaces

# Furniture supply

# 51

raw material  
colour

**U24X**

**Grey**

**Anthracite**

**Translucent**

**Translucent  
graphite**

## For furniture cabling and wiring

---

- Furniture boxes which can be supplied from the ceiling, floor or wall.
- Versatile system, composed of a round-edged box and a translucent cable runway, adaptable to any office layout.
- Mobile and light system.
- Two runway sizes and one socket box with unlimited capacity for expansion, to meet all requirements.
- Easy fixing to all kind of furniture with relocation freedom.

## Raw material

---



Furniture box



Compliant



## Technical characteristics

---

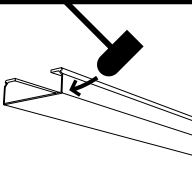
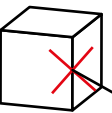
Electrical	Mechanical	Protection degree
		
<b>EN 62549</b>	<b>EN 62549</b>	<b>EN 62549</b>
Insulating material.	IK07, furniture box and trunking adapters.	IP4X, furniture box and trunking adapters.



### Furniture box

Colour

**Grey**

**RAL 7035**

**Anthracite**

### Flexible runway

Length

**1 or 3 m**

Colour

**Translucent**

### Closed rings runway

Length

**1 m**

Colour

**Translucent  
graphite**

Quality marks



Conformity declaration



See updated technical  
information of each  
part number on  
[www.unex.net](http://www.unex.net)



Public services building: office



Work spaces: office



School: library





Work spaces: office



Industrial building: office

# Supply options

From suspended ceiling

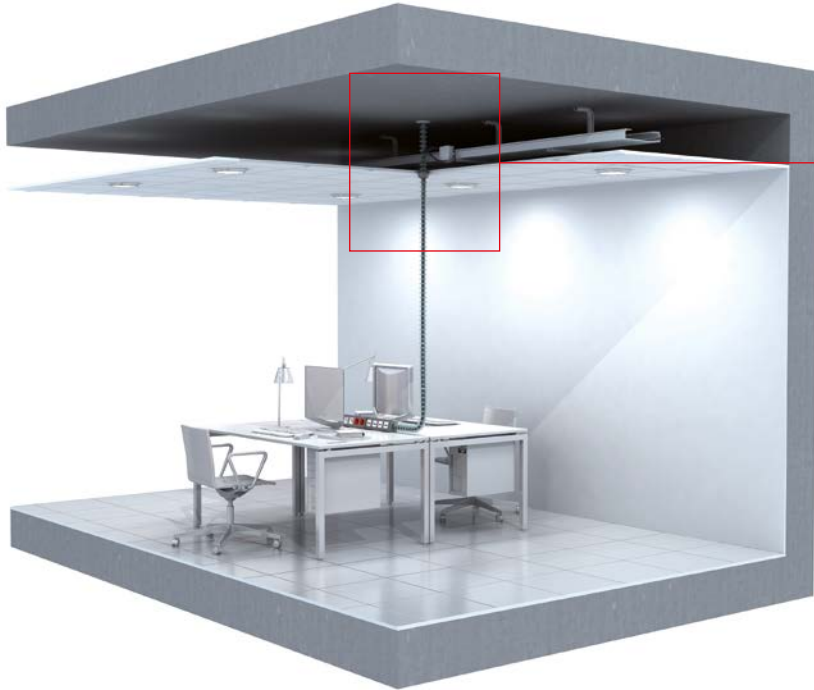

From the floor

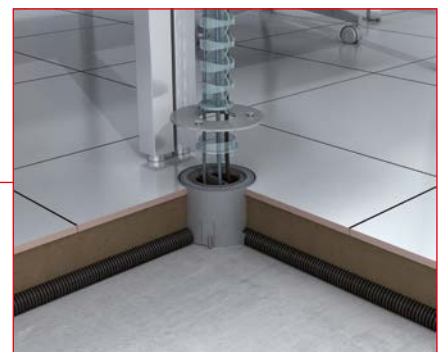
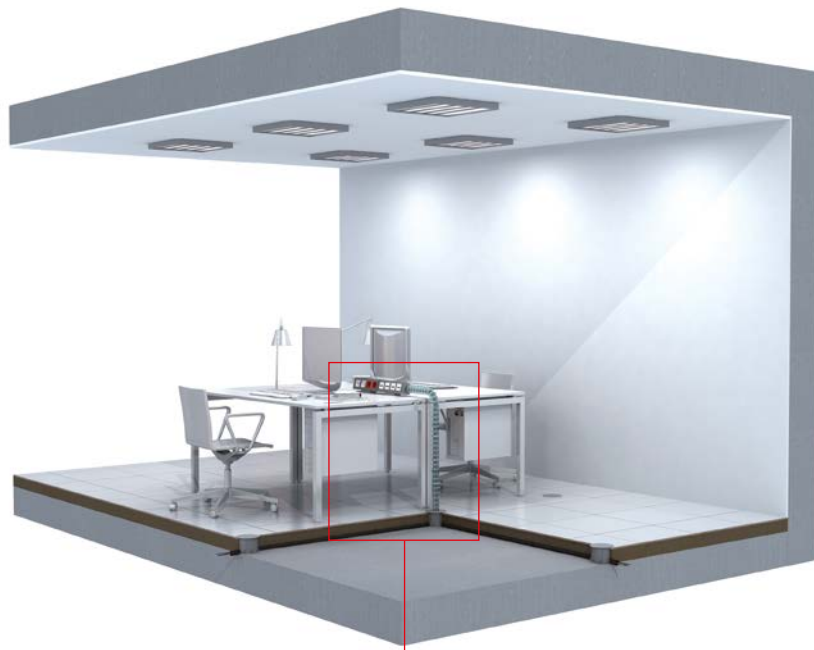

From technical floor

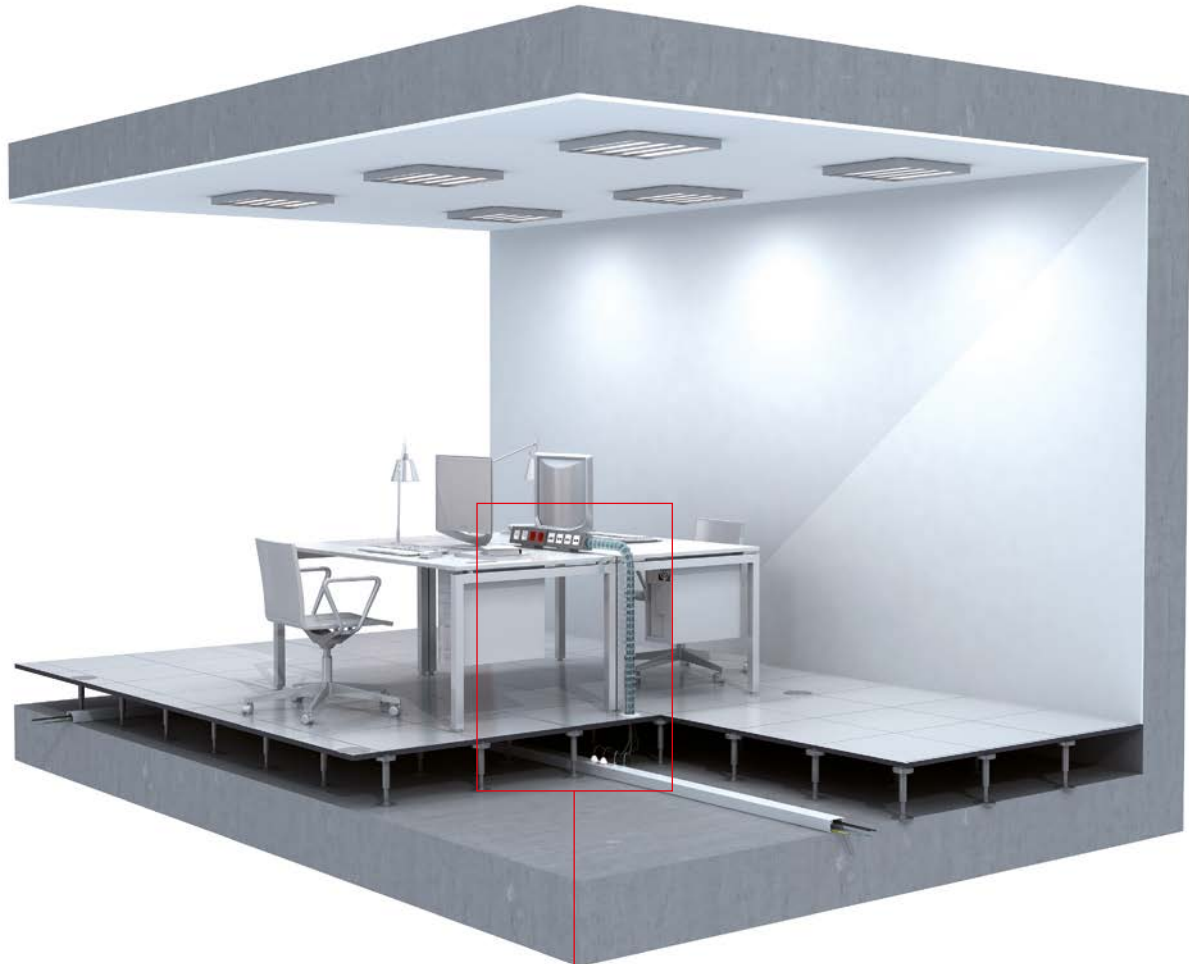



# Mounting of switches and sockets

Safe and easy mounting of switches and sockets

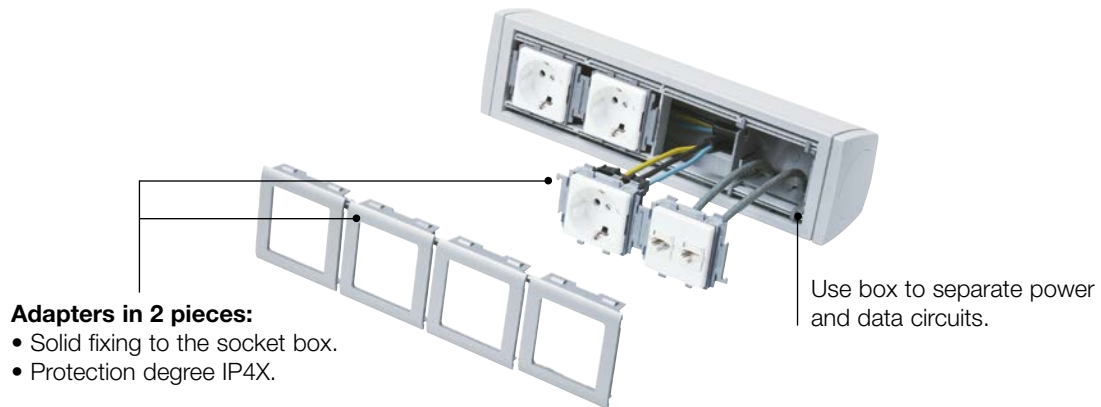

## Free choice and composition of switches and sockets

Electrical outlets

### Modular



- Niessen-Zenit\*.
- Simon\* 27.
- Mosaic\*.
- Simon Connect\* K45 and compatible.
- Eunea Unica\*.
- BJC\*, Sol.

### Modular double



- Mosaic\*.
- Simon Connect\* K45 "linkable".
- Eunea Unica\*.
- Simon CIMA 500\*.

### DIN (Bipolar)



- MCB's (Miniature circuit breakers).
- RCD's (Residual current devices).

Data connectors

### Flat plate 1 RJ45

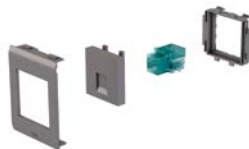

- Compatible with:
- Systimax solutions.
  - Universal type Keystone.

### Flat plate 2 RJ45



- Compatible with:
- Systimax solutions.
  - Universal type Keystone.

### Angled plate 2 RJ45



- Compatible with:
- Universal type Keystone.

**Reduced stock of fittings.** Same system for mounting switches and sockets for: Trunking 93, Modular box 85, Service pole 50, Service post 50 and Furniture supply 51.

\* These brands belong to third parties; they are not related to Unex aparellaje eléctrico, S.L.



# A system adapted to each work space

Furniture boxes can be:

- Extended according to the requirements.
- Easily relocated, thanks to their removable fixing system.

## Removable furniture box:



## Fixed furniture box:



## Without flexible runway:



## Other possibilities:



## Mechanical safety

### Solid

Suspended ceiling and floor fixings are secured by screws.

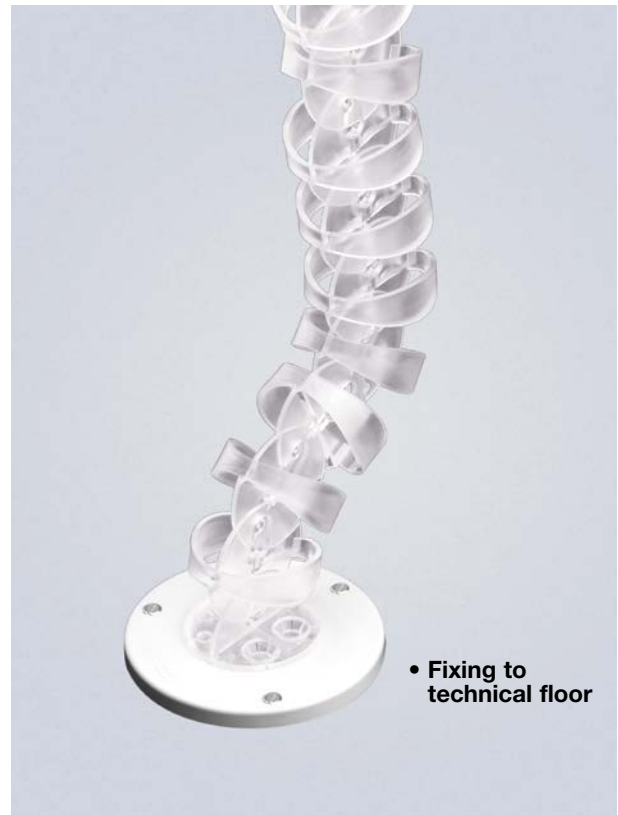

### Strong fixing to furniture

Both fixing systems assure that the furniture box remains firm and holds the pull of socket outlets.



# Electrical safety

IP4X protection degree on the furniture box inlet through the flexible runway. Cables are well-retained to avoid tugs and failures in electrical contacts.



The system's own adapters maintain the required protection degree **IP4X** when connecting to socket boxes as well as to trunking, modular box, service pole and service post.



# Easy and comfortable mounting

From the suspended ceiling

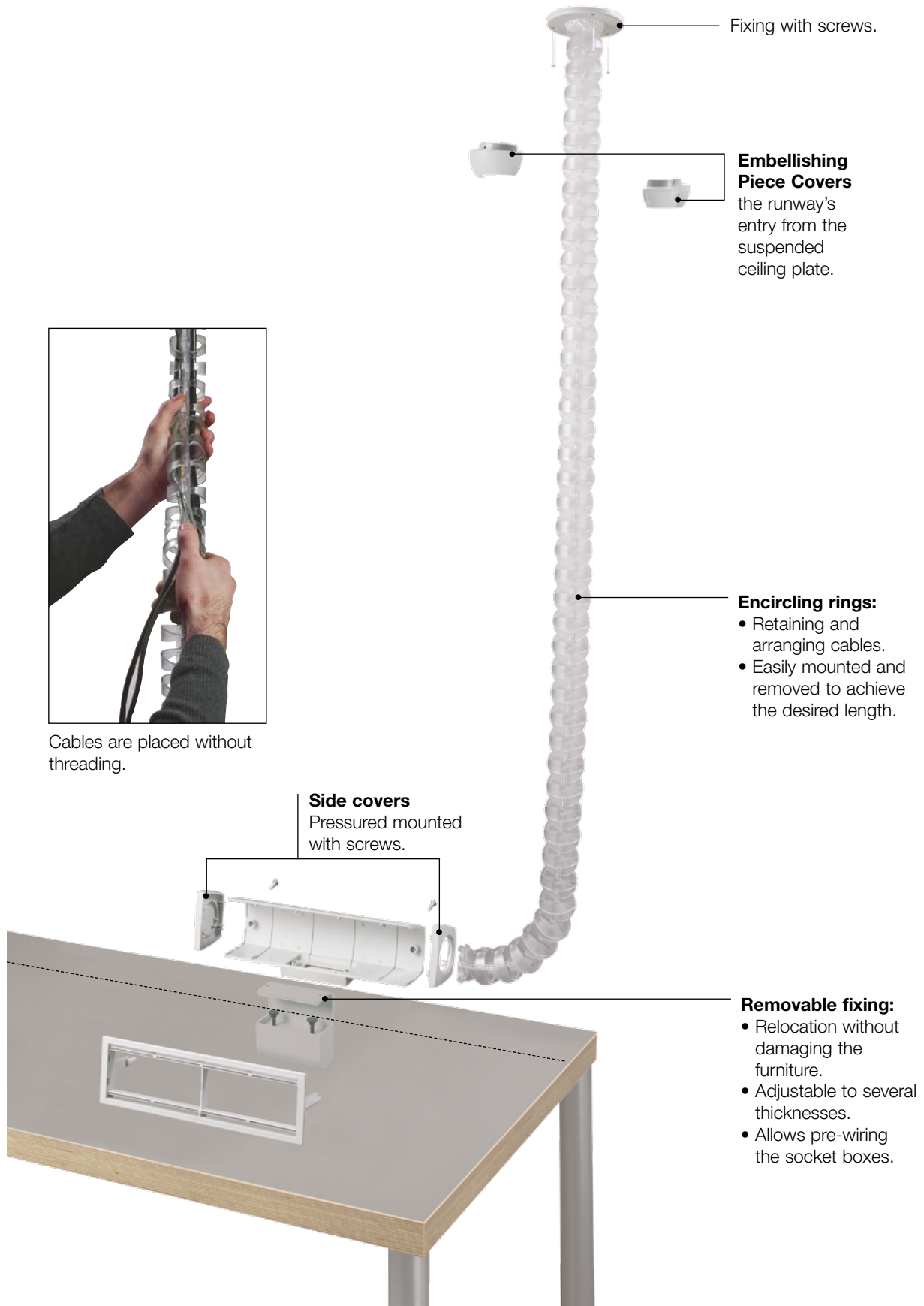



# Useful cross-section

## Passing the cables through the rings of the runway

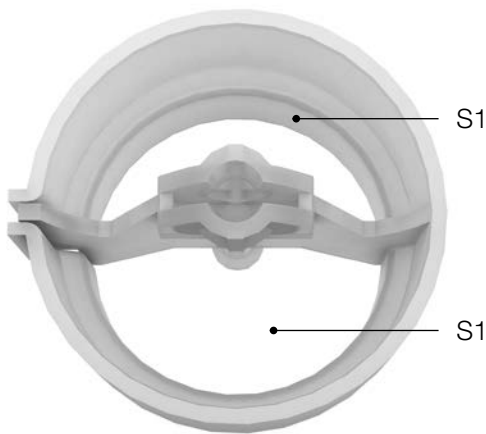

	Part number	S1 (mm <sup>2</sup> )
Closed rings runway	51601-10	525
	51601-17	
	51603-10	
Flexible runway	51602-10	670
	51606-10	

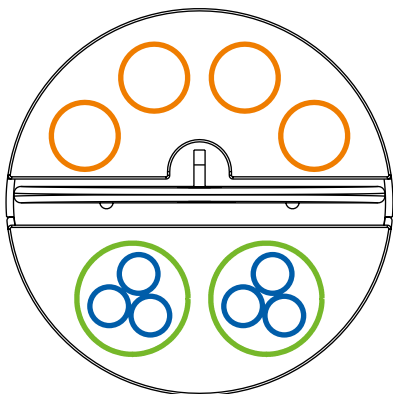

S1: same cross section

## Passing the cables through the ends of the runway





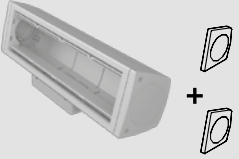
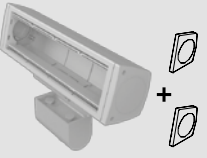

### Data and power cables

- 4 data cables Maximum Ø9 mm.
- ⊗ 2 power cables 0.6/1 kV RZ1-K 3G2.5. Maximum Ø13 mm.

	<p><b>Grey</b> RAL 7035 (Part no. 51xxx)</p> <p><b>Anthracite</b> (Part no. 51xxx-05)</p>	
	<p><b>Fixed furniture box 4 outlets</b> Linkable</p>	<b>51323</b> (1)
		<b>51323-05</b> (1)
	<p><b>Removable furniture box 4 outlets</b> Linkable For tables from 5 to 45 mm. thick</p>	<b>51423</b> (1)
		<b>51423-05</b> (1)
	<p><b>Adapter</b></p>	Essential to mount switches and sockets (See table page 206).

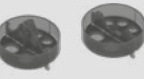

(1) Includes junction in order to mount two or more boxes.

### Flexible Runway 51 in **PC**

	<p><b>Translucent</b> (Part no. 51xxx-10)</p> <p><b>Translucent graphite</b> (Part no. 51xxx-17)</p>	
	<p><b>Flexible runway</b> End caps part no. 51600 are included</p>	L = 1 m <b>51602-10</b>
		L = 3 m <b>51606-10</b>
	<p><b>Closed rings runway</b></p>	L = 1 m <b>51601-10</b>
		L = 3 m <b>51603-10</b>
	<p><b>Flexible runway end cap</b> Includes 2 items.</p>	<b>51600-10</b>
	<p><b>Fixing clamp</b></p>	<b>51612-10</b>
	<p><b>Closed rings runway</b></p>	L = 1 m <b>51601-17</b>
	<p><b>Flexible runway end cap</b> Includes 2 items.</p>	<b>51600-17</b>

See next page 



**Runway fixings 51 in U24X**

	<p><b>Grey</b> RAL 7035 (ref. 51xxx)</p>	
	<p><b>Floor plate</b> Fixing the runway to the floor, wall and ceiling structure</p> <p><b>Grey</b></p>	<b>51610</b>
	<p><b>Suspended ceiling plate</b></p> <p><b>Grey</b></p>	<b>51611</b>

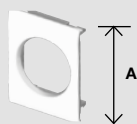

**Flexible runway 51 to Floor box 52 in SST**

	<p><b>Flexible runway lid</b></p> <p>SST</p>	<b>51814</b>
---	--	--------------

**Flexible runway 51 adapters in U24X**

	<p><b>White</b> RAL 9010 (Part no. 51xxx-2) <b>Grey</b> RAL 9006 (Part no. 51xxx-03)</p>	
	<p><b>Modular adapter for flexible runway</b></p> <p>To fix the runway to Service post and Service pole 50, Trunking 93 and Modular box 85.</p> <p><b>A = 65</b> <b>A = 80</b></p>	<p><b>51623-2</b> <b>51623-03</b> <b>51624-2</b> <b>51624-03</b></p>
	<p><b>Universal adapter for flexible runway</b></p> <p>To fix the runway to Service post and Service pole 50, Trunking 93 and Modular box 85.</p>	<b>51630-2 (1)</b>

(1) The corresponding plate and frame are necessary to fix the runway to Trunking 73 (see page 74-75).

See next page 

## Adapters for Furniture boxes 51

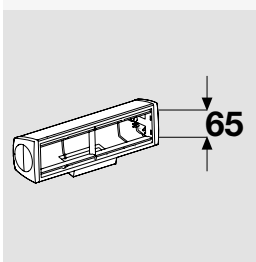

**White** RAL 9010 (Part no. 93xxx-2)  
**Aluminium** RAL 9006 (Part no. 93xxx-03)

Socket box = 4 outlets

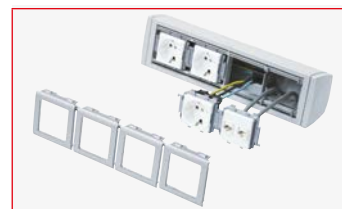

### Single plate RJ45

	Flat 1RJ45	<b>93749-2</b> (1)	<b>93749-03</b> (1)
	Flat 2RJ45	<b>93751-2</b> (1)	<b>93751-03</b> (1)
	Angled 2RJ45	<b>93753-2</b> (2)	<b>93753-03</b> (2)

### Single adapter

	Niessen Zenit*	<b>93635-2</b>	<b>93635-03</b>
	BJC* Sol	<b>93661-2</b>	<b>93661-03</b>
	Simon* 27	<b>93623-2</b>	<b>93623-03</b>
	Simon Connect* K45	<b>93608-2</b> (3)	<b>93608-03</b> (3)
	Mosaic* and compatible	<b>93608-2</b>	<b>93608-03</b>
	Eunea Unica*	<b>93653-2</b>	<b>93653-03</b>

### Double adapter + |

	Simon Connect* K45	<b>93613-2</b> (3)	<b>93613-03</b> (3)
	Mosaic* and compatible	<b>93613-2</b>	<b>93613-03</b>
	Eunea Unica*	<b>93656-2</b>	<b>93656-03</b>
	Simon CIMA 500*	<b>93640-2</b>	<b>93640-03</b>

### Adapter DIN (4)

	<b>93648-2</b>	<b>93648-03</b>
--	----------------	-----------------

### Socket boxes (5) Single adapter Double adapter

	<b>93713</b>	<b>93718</b>
--	--------------	--------------

(1) Compatible with RJ45 Systimax solutions and Universal type Keystone (AMP, Krone, Nexans, Jetlan, Belden, Brand-Rex and OPENETICS). For specific types or brands, please contact us.

(2) Compatible with RJ45 Universal type Keystone (AMP, Krone, Nexans, Jetlan, Belden, Brand-Rex and OPENETICS). For specific types or brands, please contact us.

(3) Most of the switches and sockets of K type are compatible with this adapter. However, there are some part numbers (for example KB076, KB76, K130A, 2u. KA76, 2u. K302 + K115, etc.) that can only be mounted on the double plate 93613-2/93613-03.

(4) For electrical outlets DIN, the box 93718 is necessary to fix the outlet to the furniture supply.

(5) The use of the box is necessary to assure the separation of circuits.

\* These brands belong to third parties; they are not related to Unex aparellaje eléctrico, S.L.



COPYRIGHT: All trademarks, brands or distinctive signs, of any kind, that might appear in the present website are the property of Unex aparellaje eléctrico, S.L. or of third parties. The use or access to the present website and/or to its services should not be interpreted, under no circumstances, as conferring any rights to the User on the mentioned trademarks, brands or distinctive signs.

Furthermore, all Contents are the property of Unex aparellaje eléctrico, S.L. or of third parties. As stated in the mentioned Legal Notice, none of the operation rights existing or that might exist about the mentioned Contents should be understood as transferable to the User, beyond those strictly necessary for the correct use of the Portal and the Services.

