



Cable conduction  
system with the  
possibility of mounting  
switches and sockets

# Mini trunking

# 78

raw material

**U23X**

colour

White

Grey

## Distribution and mounting of switches and sockets

- Trunking of small dimensions with external cover.
- One to three compartments to separate circuits.
- Possibility to adapt switches and sockets.
- **Can be painted.**

## Raw material

<b>U23X</b>	Mini trunking
<b>U24X</b>	Fittings, accessories and switches and sockets adapters

Compliant



## Technical characteristics

Electrical	Mechanical	Service temperature	Protection degree	In front of fire
<b>EN 50085-2-1*</b>	<b>EN 50085-2-1*</b>	<b>EN 50085-2-1*</b>	<b>EN 50085-2-1*</b>	<b>EN 50085-2-1*</b>
<p>Insulating material.</p> <hr/> <p>No earthing required.</p>	<p>IK07 Mini trunking 7x12 mm. and 10x16 mm: IK04.</p>		<p>IP4X, mounted on the wall (Mini trunking 7x12 mm. and 10x16 mm: IP3X).</p>	<p>Glow-wire test 960°C.</p> <hr/> <p>Non flame propagating.</p> <hr/> <p>Reaction to fire, Class M1 acc./UNE 201010.</p> <hr/> <p>Flammability degree UL94: V0. Does not spread fire by dripping.</p>

\* BS EN 50085-2-1 is the UK implementation of EN 50085-2-1.



Length

**2 m**

Colour

White

**RAL 9010**

Grey

**RAL 7035**

## Quality marks



## Approvals



## Conformity declaration



See updated technical  
information of each  
part number on  
[www.unex.net](http://www.unex.net)

78

U23X  
White / Grey

Mini trunking



Work spaces: office



Apartment building renovation



School: library



Health care: kitchen



Apartment building renovation



Hotel industry



Apartment building renovation

# Easy installation

## Mini trunking and fittings

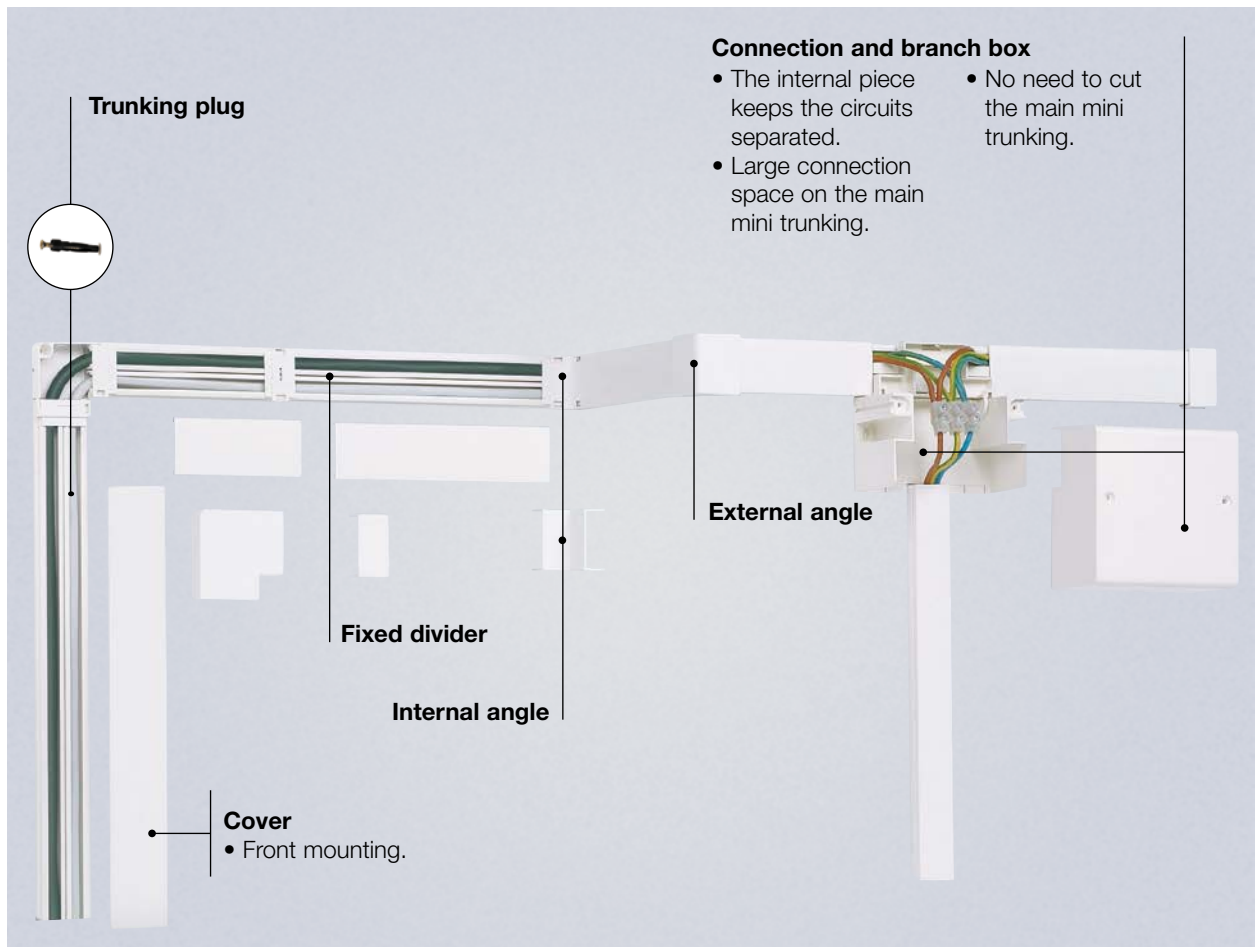

## Fittings in 2 pieces

### Internal angle



### External angle

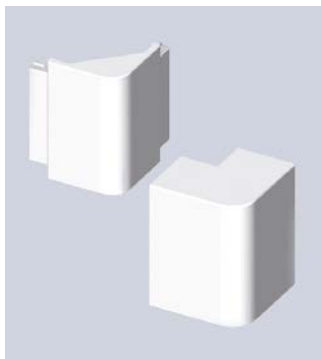

**The internal piece** allows easy measuring of the cover and holds the cables.

**The external piece** covers the cut marks of base and cover. It is not necessary to slide the cover. Assures protection degree IP4X.

# Adapting switches and sockets

Mounting switches and sockets, using Unex boxes

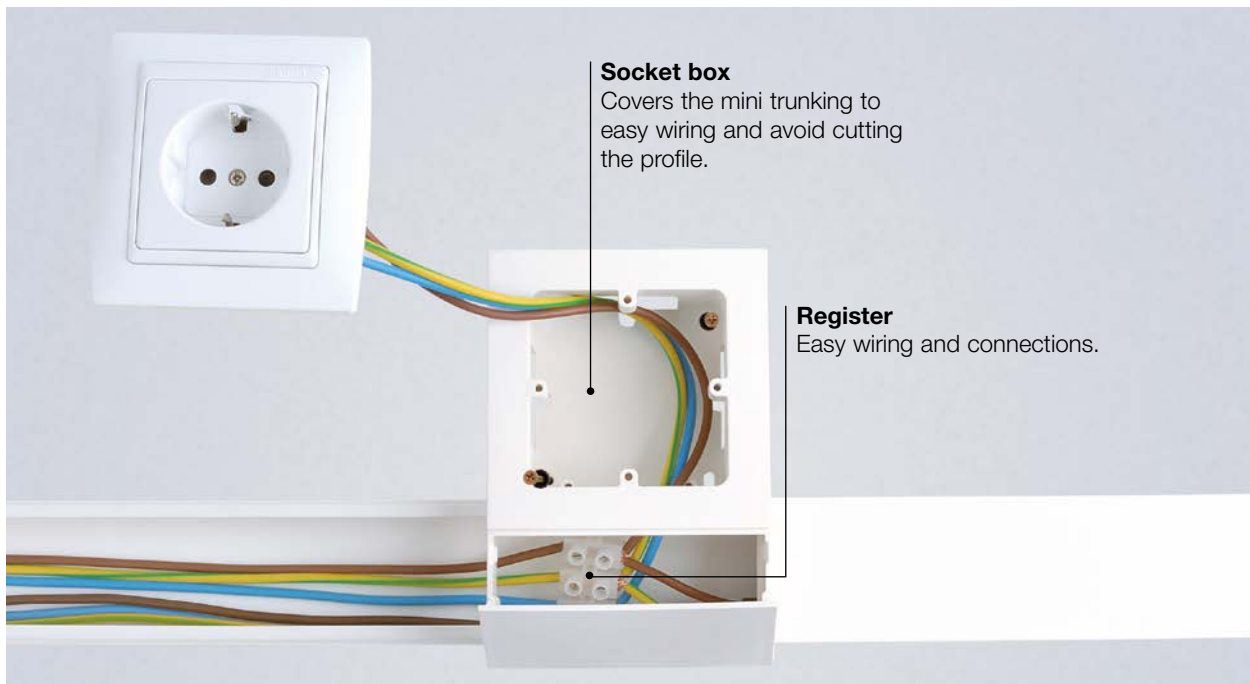

Flexibility to combine a variety of switches and sockets

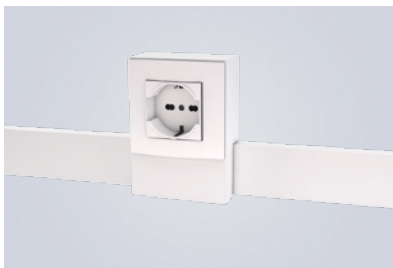

### Universal CEE-7

- Niessen\* Olas, Arco, Tacto, Zenit and Stylo.
- Jung\*.
- Simon\* 31, 75, 82, 88.
- Valena\*.
- Bticino\*.
- Eunea\*.
- Berker\*.



### Modular

- Simon\* 27.
- Mosaic\*.
- Simon Connect\* K 45.



### Universal

- Niessen Zenit\*.
- Bticino\*.
- Unica-Allegro (3 modules).
- Gewiss\*.



### Surface mounting

- Oteo\*.



### Surface mounting

- Simon\* 73 Loft.

\*These brands belong to third parties, they are not related to Unex aparellaje eléctrico, S.L.

## Individual boxes 78

To mount modular outlets

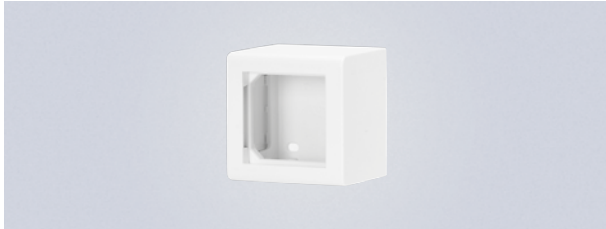

Simon\* 27 box

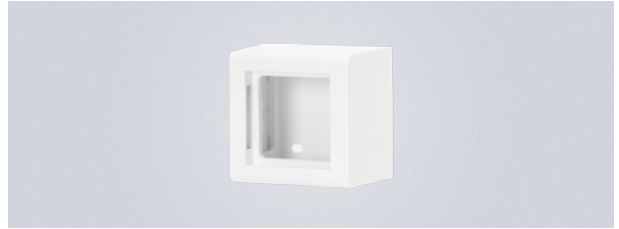

Mosaic\* box

2 mounting possibilities: side or front

To combine boxes with Unex mini trunking system

**Side adaptation**



**Front adaptation**



## Modular boxes 85

Three sizes: 4, 6 or 8 outlets



4 outlets



6 outlets



8 outlets

2 mounting possibilities: side or front

To combine boxes with Unex mini trunking system

**Side adaptation**



**Front adaptation**





## Front adaptation to mini trunking

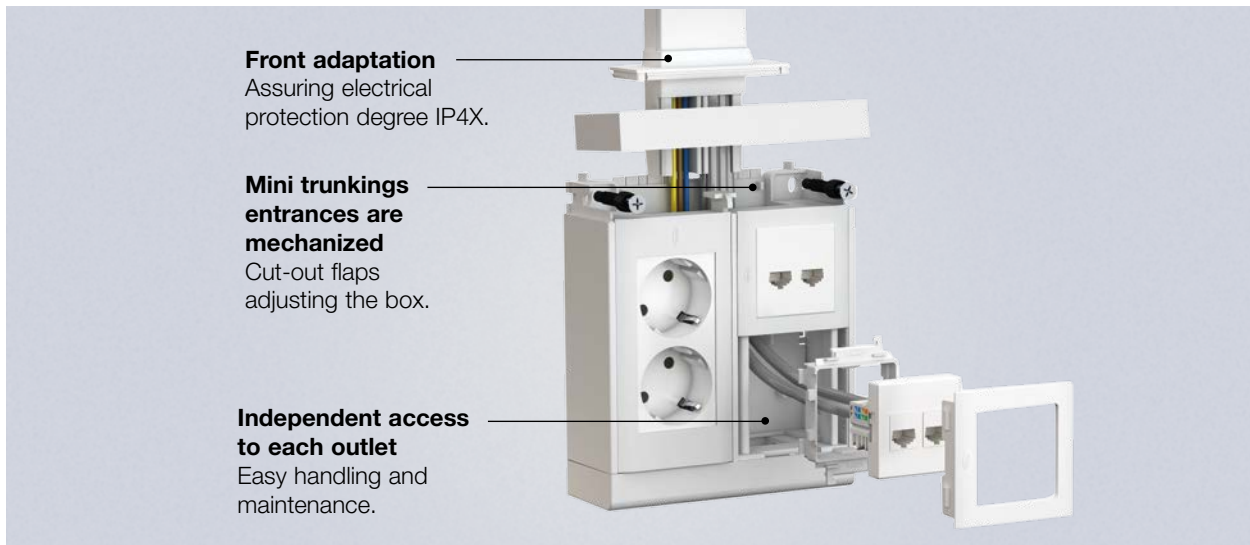

## Flexibility to combine a variety of switches and sockets for Modular box 85

- Customization according to the necessities of each user.
- Possibility to adapt and combine a large range of modular outlet on the market.

## Electrical outlets

### Modular



- Niessen Zenit\*.
- Simon\* 27.
- Simon Connect\* K45 and compatible.
- Mosaic\*.
- Eunea Unica\*
- BJC Sol\*.

### Modular double



- Mosaic\*.
- Simon Connect\* K45.
- Eunea Unica\*.
- Simon CIMA 500\*.

### DIN (Bipolar)



- MCB's (Miniature circuit breakers).
- RCD's (Residual current devices).

## Data connectors

### Flat plate 1 RJ45



- Compatible with:
- Systemax solutions.
  - Universal type Keystone.

### Flat plate 2 RJ45



- Compatible with:
- Systemax solutions.
  - Universal type Keystone.







### Angled plate 2 RJ45









- Compatible with:
- Universal type Keystone.

**Reduced stock of fittings:** Same system for mounting switches and sockets for: Trunking 93, Modular box 85, Service pole 50, Service post 50 and Furniture supply 51.





\* These brands belong to third parties, they are not related to Unex aparellaje eléctrico, S.L.

	Mini trunking sizes (mm)	7x12	10x16	10x22	10x30
	<p><b>White</b> RAL 9010 (Part no. 78xxx-2 and Part no. 78xxx-2A)</p> <p><b>Grey</b> RAL 7035 (Part no. 78xxx-04)</p>				
	<b>Mini trunking</b> 2 m	<b>78010-2</b>	<b>78021-2</b>	<b>78022-2</b>	<b>78023-2</b>
	<b>Self-adhesive mini trunking</b> 2 m	<b>78010-2A</b>	<b>78021-2A</b>	<b>78022-2A</b>	
	<b>Mini trunking with divider</b> 2 m				

### Fittings in **U24X**

	<b>Flat angle</b>			<b>78222-2</b>	<b>78223-2</b>
	<b>External angle</b>			<b>78272-2</b>	<b>78273-2</b>
	<b>Internal angle</b>			<b>78322-2</b>	<b>78323-2</b>
	<b>End cover</b>			<b>78372-2</b>	<b>78373-2</b>
	<b>Branch</b>			<b>78472-2</b>	<b>78473-2</b>
	<b>Joint cover piece</b>			<b>78522-2</b>	<b>78523-2</b>

### Connection and branch box in **U24X**

	70x70x27 mm			<b>78455-2</b>	
	85x85x45 mm			<b>71451-2</b>	
	110x110x45 mm			<b>78457-2</b>	
	110x150x74 mm			<b>73461-2</b>	
	<b>Connection and branch box</b> Note: screws are included.			<b>78503-2</b>	

### Fixing elements in **U63X**

	<b>Trunking plug</b> Note: Use bit Ø4 mm.			<b>25104</b>	
---	--	--	--	--------------	--









16x16	16x30	16x50	20x30	20x50	20x75
<b>78031-2</b> <b>78031-04</b>	<b>78033-2</b>		<b>78043-2</b> <b>78043-04</b>	<b>78045-2</b>	
<b>78031-2A</b>	<b>78033-2A</b>				
	<b>78083-2</b>	<b>78085-2</b>	<b>78093-2</b>	<b>78095-2</b>	<b>78147-2</b>

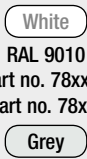

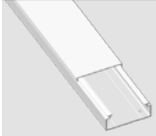

<b>78231-2</b> <b>78231-04</b>	<b>78233-2</b>	<b>78235-2</b>	<b>78243-2</b> <b>78243-04</b>	<b>78245-2</b>	<b>78247-2</b>
<b>78281-2</b> <b>78281-04</b>	<b>78283-2</b>	<b>78285-2</b>	<b>78293-2</b> <b>78293-04</b>	<b>78295-2</b>	<b>78297-2</b>
<b>78331-2</b> <b>78331-04</b>	<b>78333-2</b>	<b>78335-2</b>	<b>78343-2</b> <b>78343-04</b>	<b>78345-2</b>	<b>78347-2</b>
<b>78381-2</b> <b>78381-04</b>	<b>78383-2</b>	<b>78385-2</b>	<b>78393-2</b> <b>78393-04</b>	<b>78395-2</b>	<b>78397-2</b>
<b>78481-2</b>	<b>78483-2</b>	<b>78485-2</b>	<b>78493-2</b>	<b>78495-2</b>	<b>78497-2</b>
<b>78531-2</b> <b>78531-04</b>	<b>78533-2</b>	<b>78535-2</b>	<b>78543-2</b> <b>78543-04</b>	<b>78545-2</b>	<b>78547-2</b>

<b>78455-2</b>					
<b>71451-2</b>					
<b>78457-2</b> <b>78457-04</b>	<b>78457-2</b>		<b>78457-2</b> <b>78457-04</b>	<b>78457-2</b>	
<b>73461-2</b> <b>73461-04</b>	<b>73461-2</b>		<b>73461-2</b> <b>73461-04</b>	<b>73461-2</b>	
<b>78503-2</b>		<b>78507-2</b>	<b>78503-2</b>	<b>78507-2</b>	

<b>25104</b>
--------------

Mini trunking sizes (mm)		7x12	10x16	10x22	10x30
	<p><b>White</b> RAL 9010 (Part no. 78xxx-2 and Part no. 78xxx-2A)</p> <p><b>Grey</b> RAL 7035 (Part no. 78xxx-04)</p>				
	<p><b>Mini trunking</b> 2 m</p> <hr/> <p><b>Self-adhesive mini trunking</b> 2 m</p>	<b>78010-2</b>	<b>78021-2</b>	<b>78022-2</b>	<b>78023-2</b>
	<b>Mini trunking with divider</b> 2 m				

### Adapters for switches and sockets in **U24X**

	<b>Adapter for 1 universal outlet</b>			<b>78740-2</b>
	<b>Adapter for 2 universal outlets</b>			<b>78741-2</b>
	<b>Adapter for 1 Simon* 73 loft</b>			<b>78860-2</b>
	<b>Adapter for 1 Oteo* outlet</b>			<b>78870-2</b>

\* These brands belong to third parties, they are not related to Unex aparellaje eléctrico, S.L.











	16x16	16x30	16x50	20x30	20x50	20x75
	<b>78031-2</b> <b>78031-04</b>	<b>78033-2</b>		<b>78043-2</b> <b>78043-04</b>	<b>78045-2</b>	
	<b>78031-2A</b>	<b>78033-2A</b>				
		<b>78083-2</b>	<b>78085-2</b>	<b>78093-2</b>	<b>78095-2</b>	<b>78147-2</b>





<b>78740-2</b>				
<b>78741-2</b>				
<b>78860-2</b>	<b>78862-2</b>	<b>78860-2</b>	<b>78862-2</b>	
<b>78880-2</b>		<b>78890-2</b>		

See next page

Mounting of surface boxes in **U24X**

		Mini trunking sizes (mm)								
		10x22	10x30	16x16	16x30	16x50	20x30	20x50	20x75	
	Mini trunking without divider (1 compartment)	78022-2 78022-2A	78023-2	78031-2 78031-2A	78033-2 78033-2A		78043-2	78045-2		
	Mini trunking with 1 divider (2 compartments)				78083-2	78085-2	78093-2	78095-2		
	Mini trunking with 2 dividers (3 compartments)								78147-2	
	<b>Side adapter</b>	78622-2	78623-2	78631-2	78633-2	78635-2	78643-2	78645-2	78647-2	
	<b>Front adapter</b>	78672-2	78673-2	78681-2	78683-2		78693-2			
	<b>Simón* 27 box</b>	78757-2								
	<b>Mosaic* box</b>	78756-2								
	<b>Universal</b> Note: 2 screws and 1 cover part no. 7850-2 are included.	78759-2								
	<b>Modular box 4 outlets</b> Note: 4 Trunking plugs part no. 25106 included. <b>Adapters for switches and sockets</b>						85023-2			
		See table next page.								
	<b>Modular box 6 outlets</b> Note: 4 Trunking plugs part no. 25106 included. <b>Adapters for switches and sockets</b>						85033-2			
		See table next page.								
	<b>Modular box 8 outlets</b> Note: 4 Trunking plugs part no. 25106 included. <b>Adapters for switches and sockets</b>						85043-2			
		See table next page.								

Universal adaptation of the Flexible runway 51 in **U24X** (See Furniture supply 51)

	<b>Universal adapter for Flexible runway 51</b>	51630-2								
	<b>Adapter for 1 Universal CEE-7 outlet</b>	78740-2								
	<b>Modular adapter for Flexible runway 51</b>	51623-2								
	<b>Modular box</b> 4 outlets	85023-2								
	Note: 4 Trunking plugs part no. 25106 included. 6 outlets	85033-2								
	8 outlets	85043-2								

Socket box cover in **U24X**

	<b>Socket box cover</b>	78650-2								
---	-------------------------	---------	--	--	--	--	--	--	--	--

\*These brands belong to third parties; they are not related to Unex aparellaje eléctrico, S.L.

## Adapters for Modular boxes 85

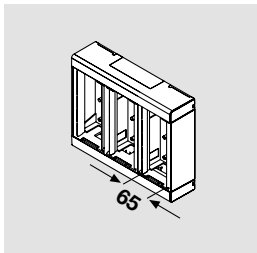

4 outlets

6 outlets

8 outlets

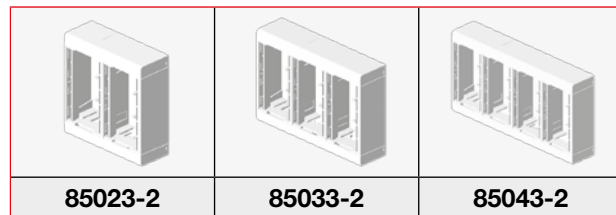

### Single plate RJ45

	Flat 1RJ45	<b>93749-2</b> (1)
	Flat 2RJ45	<b>93751-2</b> (1)
	Angled 2RJ45	<b>93753-2</b> (2)

### Single adapter

	Niessen Zenit*	<b>93635-2</b> (3)
	BJC* Sol	<b>93663-2</b>
	Simon* 27	<b>93621-2</b>
	Simon Connect* K45	<b>93608-2</b> (4)
	Mosaic* and compatible	<b>93608-2</b>
	Eunea Unica*	<b>93653-2</b>

### Double adapter + |

	Simon CIMA 500*	<b>93640-2</b>
	Simon Connect* K45	<b>93613-2</b> (4)
	Mosaic* and compatible	<b>93613-2</b>
	Eunea Unica*	<b>93656-2</b>

### Adapter DIN

	<b>93648-2</b>
--	----------------

(1) Compatible with RJ45 Systimax solutions and Universal type Keystone (AMP, Krone, Nexans, Jetlan, Belden, Brand-Rex and OPENETICS). For specific types or brands, please contact us.

(2) Compatible with RJ45 Universal type Keystone (AMP, Krone, Nexans, Jetlan, Belden, Brand-Rex and OPENETICS). For specific types or brands, please contact us.

(3) The adapters for Niessen Zenit outlets are designed for horizontal mounting. Vertical mounting cases, outlets will be turned 90° from original position.

(4) Most of the switches and sockets of K type are compatible with this adapter. However, there are some part numbers (for example KB076, KB76, K130A, 2u. KA76, 2u. K302 + K115, etc.) that can only be mounted on the double plate 93613-2 in the central area, placing blind lids on the sides.







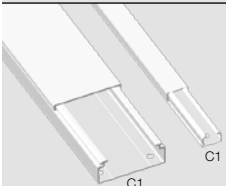

\*These brands belong to third parties; they are not related to Unex aparellaje eléctrico, S.L.

See next page





Useful cross-sections (mm<sup>2</sup>)

Recommended capacity with conductors H07V-K

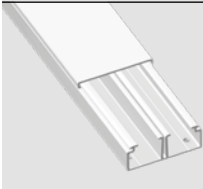

Sizes (mm) 7x12 10x16 10x22 10x30 16x16 16x30 16x50 20x30 20x50 20x75

<b>Part no.</b>		<b>78010-2</b>	<b>78021-2</b>	<b>78022-2</b>	<b>78023-2</b>	<b>78031-2</b>	<b>78033-2</b>		<b>78043-2</b>	<b>78045-2</b>	
	<b>RAL 9010 / RAL 7035</b>	<b>78010-2A</b>	<b>78021-2A</b>	<b>78022-2A</b>		<b>78031-2A</b>	<b>78033-2A</b>		<b>78043-04</b>		
		 46	 100	 143	 205	 150	 323		 437	 764	
Compartments		C1	C1	C1	C1	C1	C1		C1	C1	
Quantity of recommended conductors type H07V-K	1.5 mm <sup>2</sup>	2	4	6	9	6	14		18	32	
	2.5 mm <sup>2</sup>	1	3	4	6	4	9		12	21	
	4 mm <sup>2</sup>	1	2	3	4	3	7		9	17	
	6 mm <sup>2</sup>		1	2	3	2	4		5	10	

Sizes (mm) 7x12 10x16 10x22 10x30 16x16 16x30 16x50 20x30 20x50 20x75

<b>Part no.</b>									<b>78083-2</b>	<b>78085-2</b>	<b>78093-2</b>	<b>78095-2</b>	
	<b>RAL 9010</b>												
									 136	 262	 184	 343	
Compartments									C1 C2	C1 C2	C1 C2	C1 C2	
Quantity of recommended conductors type H07V-K	1.5 mm <sup>2</sup>								6 6	11 11	8 8	14 14	
	2.5 mm <sup>2</sup>								4 4	7 7	5 5	9 9	
	4 mm <sup>2</sup>								3 3	6 6	4 4	7 7	
	6 mm <sup>2</sup>								2 2	3 3	2 2	4 4	

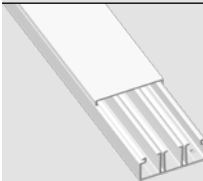
Sizes (mm) 7x12 10x16 10x22 10x30 16x16 16x30 16x50 20x30 20x50 20x75

<b>Part no.</b>													<b>78147-2</b>
	<b>RAL 9010</b>												
													 337
Compartments													C1 C2 C3
Quantity of recommended conductors type H07V-K	1.5 mm <sup>2</sup>												14 15 14
	2.5 mm <sup>2</sup>												9 10 9
	4 mm <sup>2</sup>												7 8 7
	6 mm <sup>2</sup>												4 4 4





COPYRIGHT: All trademarks, brands or distinctive signs, of any kind, that might appear in the present website are the property of Unex aparellaje eléctrico, S.L. or of third parties. The use or access to the present website and/or to its services should not be interpreted, under no circumstances, as conferring any rights to the User on the mentioned trademarks, brands or distinctive signs.

Furthermore, all Contents are the property of Unex aparellaje eléctrico, S.L. or of third parties. As stated in the mentioned Legal Notice, none of the operation rights existing or that might exist about the mentioned Contents should be understood as transferable to the User, beyond those strictly necessary for the correct use of the Portal and the Services.

