



Cable conduction
system with the
possibility of mounting
switches and sockets

Mini trunking

78

raw material

U23X

colour

White

Grey

Distribution and mounting of switches and sockets

- Trunking of small dimensions with external cover.
- One to three compartments to separate circuits.
- Possibility to adapt switches and sockets.
- **Can be painted.**

Raw material

| | |
|-------------|---|
| U23X | Mini trunking |
| U24X | Fittings, accessories and switches and sockets adapters |

Compliant



Technical characteristics

| Electrical | Mechanical | Service temperature | Protection degree | In front of fire |
|--|--|----------------------|---|--|
| | | | | |
| EN 50085-2-1* | EN 50085-2-1* | EN 50085-2-1* | EN 50085-2-1* | EN 50085-2-1* |
| <p>Insulating material.</p> <hr/> <p>No earthing required.</p> | <p>IK07 Mini trunking 7x12 mm. and 10x16 mm: IK04.</p> | | <p>IP4X, mounted on the wall (Mini trunking 7x12 mm. and 10x16 mm: IP3X).</p> | <p>Glow-wire test 960°C.</p> <hr/> <p>Non flame propagating.</p> <hr/> <p>Reaction to fire, Class M1 acc./UNE 201010.</p> <hr/> <p>Flammability degree UL94: V0. Does not spread fire by dripping.</p> |

* BS EN 50085-2-1 is the UK implementation of EN 50085-2-1.



Length

2 m

Colour

White

RAL 9010

Grey

RAL 7035

Quality marks



Approvals



Bureau Veritas

Φ3 от 22.07.08 N 123-Φ3
ГОСТ P 53313-2009

Conformity declaration

See updated technical
information of each
part number on
www.unex.net

78

U23X
White / Grey

Mini trunking



Work spaces: office



Apartment building renovation



School: library



Health care: kitchen



Apartment building renovation



Hotel industry



Apartment building renovation

Easy installation

Mini trunking and fittings

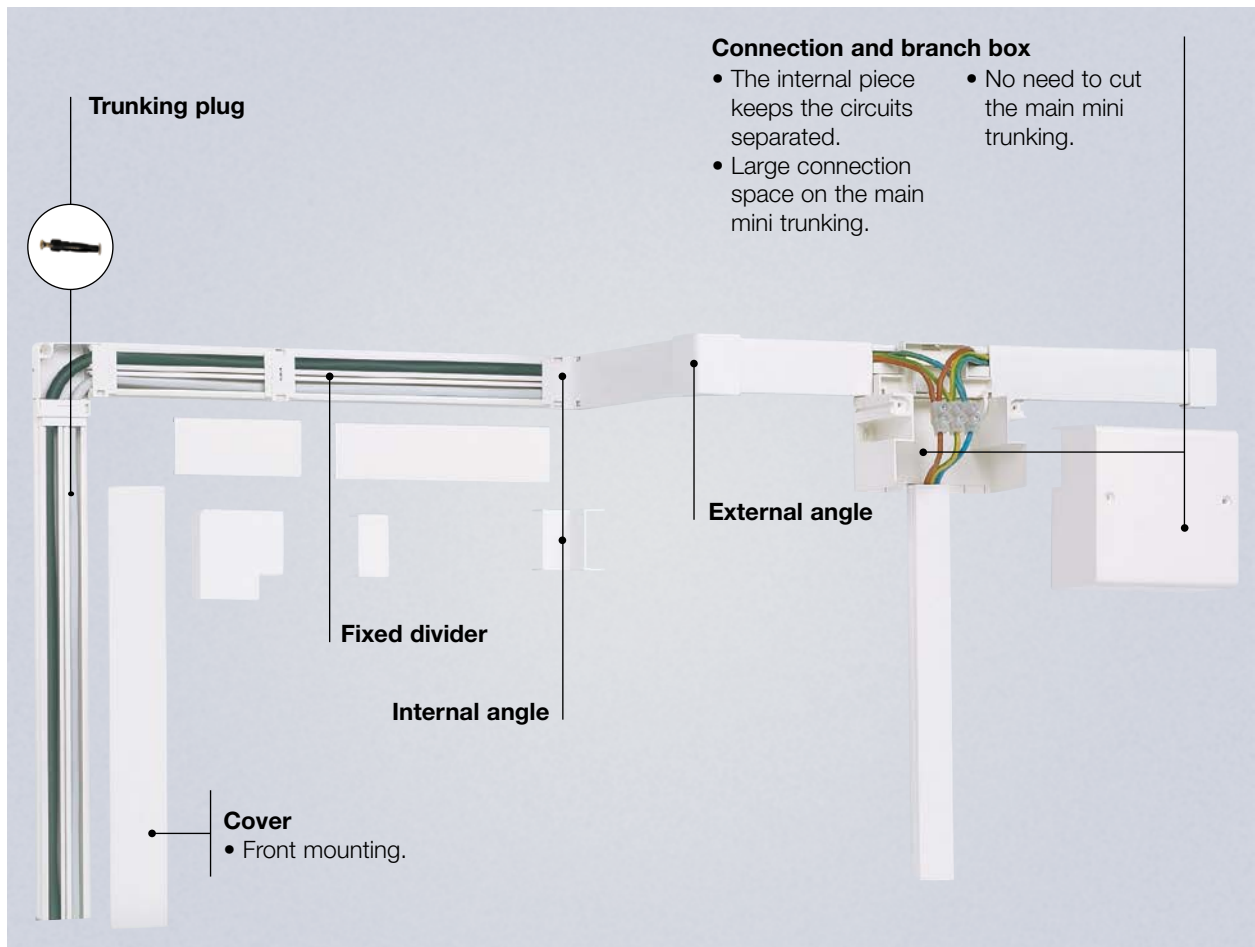

Fittings in 2 pieces

Internal angle



External angle

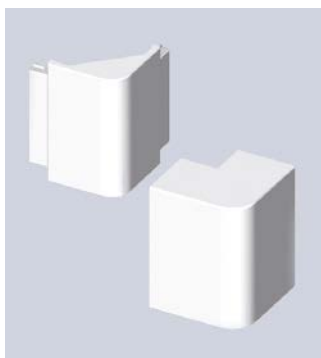

The internal piece allows easy measuring of the cover and holds the cables.

The external piece covers the cut marks of base and cover. It is not necessary to slide the cover. Assures protection degree IP4X.

Adapting switches and sockets

Mounting switches and sockets, using Unex boxes

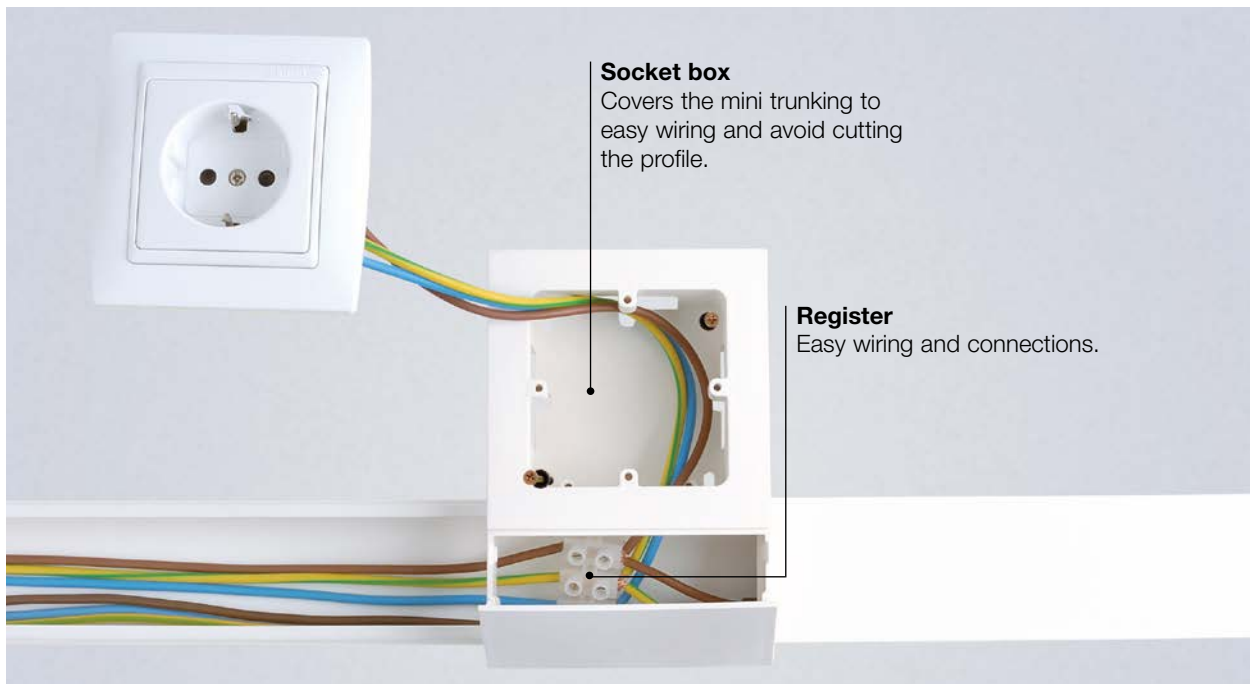

Flexibility to combine a variety of switches and sockets

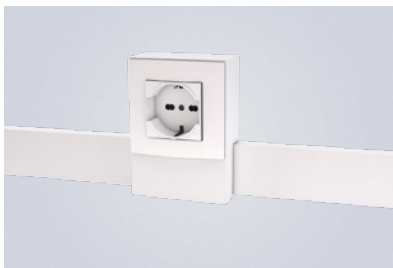

Universal CEE-7

- Niessen* Olas, Arco, Tacto, Zenit and Stylo.
- Jung*.
- Simon* 31, 75, 82, 88.
- Valena*.
- Bticino*.
- Eunea*.
- Berker*.



Modular

- Simon* 27.
- Mosaic*.
- Simon Connect* K 45.



Universal

- Niessen Zenit*.
- Bticino*.
- Unica-Allegro (3 modules).
- Gewiss*.



Surface mounting

- Oteo*.



Surface mounting

- Simon* 73 Loft.

*These brands belong to third parties, they are not related to Unex aparellaje eléctrico, S.L.

Individual boxes 78

To mount modular outlets

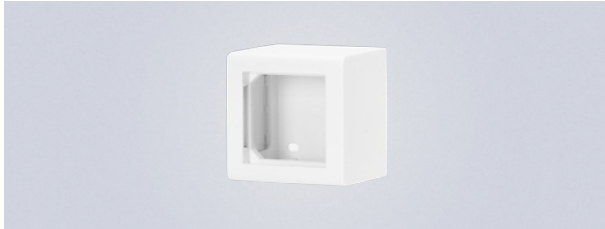

Simon* 27 box

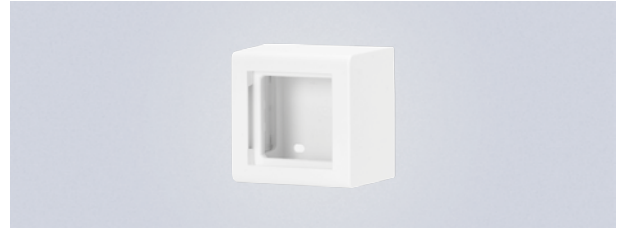

Mosaic* box

2 mounting possibilities: side or front

To combine boxes with Unex mini trunking system

Side adaptation



Front adaptation



Modular boxes 85

Three sizes: 4, 6 or 8 outlets



4 outlets



6 outlets



8 outlets

2 mounting possibilities: side or front

To combine boxes with Unex mini trunking system

Side adaptation



Front adaptation



Front adaptation to mini trunking

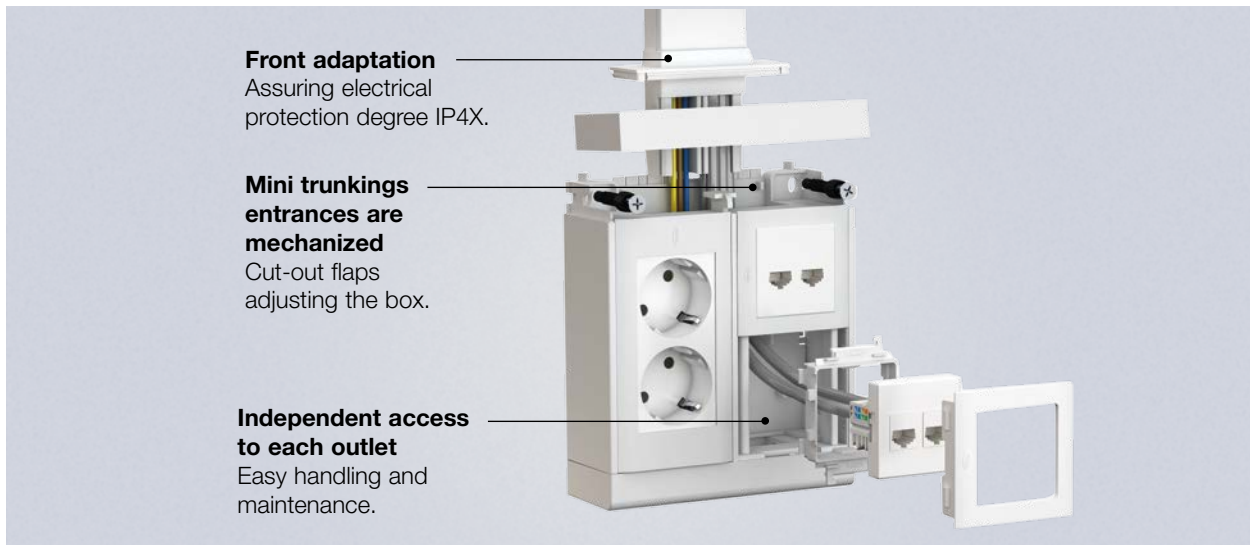

Flexibility to combine a variety of switches and sockets for Modular box 85

- Customization according to the necessities of each user.
- Possibility to adapt and combine a large range of modular outlet on the market.

Electrical outlets

Modular



- Niessen Zenit*.
- Simon* 27.
- Simon Connect* K45 and compatible.
- Mosaic*.
- Eunea Unica*
- BJC Sol*.

Modular double



- Mosaic*.
- Simon Connect* K45.
- Eunea Unica*.
- Simon CIMA 500*.

DIN (Bipolar)



- MCB's (Miniature circuit breakers).
- RCD's (Residual current devices).

Data connectors

Flat plate 1 RJ45



- Compatible with:
- Systemax solutions.
 - Universal type Keystone.

Flat plate 2 RJ45



- Compatible with:
- Systemax solutions.
 - Universal type Keystone.







Angled plate 2 RJ45









- Compatible with:
- Universal type Keystone.

Reduced stock of fittings: Same system for mounting switches and sockets for: Trunking 93, Modular box 85, Service pole 50, Service post 50 and Furniture supply 51.





* These brands belong to third parties, they are not related to Unex aparellaje eléctrico, S.L.

| | Mini trunking sizes (mm) | 7x12 | 10x16 | 10x22 | 10x30 |
|---|---|---|--|---|---|
| | <p>White RAL 9010 (Part no. 78xxx-2 and Part no. 78xxx-2A)</p> <p>Grey RAL 7035 (Part no. 78xxx-04)</p> |  |  |  |  |
|  | Mini trunking 2 m | 78010-2 | 78021-2 | 78022-2 | 78023-2 |
| | Self-adhesive mini trunking 2 m | 78010-2A | 78021-2A | 78022-2A | |
|  | Mini trunking with divider 2 m | | | | |

Fittings in **U24X**

| | | | | | |
|---|--------------------------|--|--|----------------|----------------|
|  | Flat angle | | | 78222-2 | 78223-2 |
|  | External angle | | | 78272-2 | 78273-2 |
|  | Internal angle | | | 78322-2 | 78323-2 |
|  | End cover | | | 78372-2 | 78373-2 |
|  | Branch | | | 78472-2 | 78473-2 |
|  | Joint cover piece | | | 78522-2 | 78523-2 |

Connection and branch box in **U24X**

| | | | | | |
|---|--|--|--|----------------|--|
|  | 70x70x27 mm | | | 78455-2 | |
|  | 85x85x45 mm | | | 71451-2 | |
|  | 110x110x45 mm | | | 78457-2 | |
|  | 110x150x74 mm | | | 73461-2 | |
|  | Connection and branch box Note: screws are included. | | | 78503-2 | |

Fixing elements in **U63X**

| | | | | | |
|---|--|--|--|--------------|--|
|  | Trunking plug Note: Use bit Ø4 mm. | | | 25104 | |
|---|--|--|--|--------------|--|









| 16x16 | 16x30 | 16x50 | 20x30 | 20x50 | 20x75 |
|-----------------------------------|-----------------|----------------|-----------------------------------|----------------|----------------|
| | | | | | |
| 78031-2 78031-04 | 78033-2 | | 78043-2 78043-04 | 78045-2 | |
| 78031-2A | 78033-2A | | | | |
| | 78083-2 | 78085-2 | 78093-2 | 78095-2 | 78147-2 |

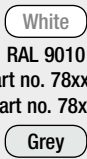

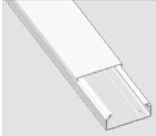

| | | | | | |
|-----------------------------------|----------------|----------------|-----------------------------------|----------------|----------------|
| 78231-2 78231-04 | 78233-2 | 78235-2 | 78243-2 78243-04 | 78245-2 | 78247-2 |
| 78281-2 78281-04 | 78283-2 | 78285-2 | 78293-2 78293-04 | 78295-2 | 78297-2 |
| 78331-2 78331-04 | 78333-2 | 78335-2 | 78343-2 78343-04 | 78345-2 | 78347-2 |
| 78381-2 78381-04 | 78383-2 | 78385-2 | 78393-2 78393-04 | 78395-2 | 78397-2 |
| 78481-2 | 78483-2 | 78485-2 | 78493-2 | 78495-2 | 78497-2 |
| 78531-2 78531-04 | 78533-2 | 78535-2 | 78543-2 78543-04 | 78545-2 | 78547-2 |

| | | | | | |
|-----------------------------------|----------------|----------------|-----------------------------------|----------------|--|
| 78455-2 | | | | | |
| 71451-2 | | | | | |
| 78457-2 78457-04 | 78457-2 | | 78457-2 78457-04 | 78457-2 | |
| 73461-2 73461-04 | 73461-2 | | 73461-2 73461-04 | 73461-2 | |
| 78503-2 | | 78507-2 | 78503-2 | 78507-2 | |

| |
|--------------|
| 25104 |
|--------------|

| Mini trunking sizes (mm) | | 7x12 | 10x16 | 10x22 | 10x30 |
|---|---|---|--|---|---|
|  | <p>White RAL 9010 (Part no. 78xxx-2 and Part no. 78xxx-2A)</p> <p>Grey RAL 7035 (Part no. 78xxx-04)</p> |  |  |  |  |
|  | <p>Mini trunking 2 m</p> <hr/> <p>Self-adhesive mini trunking 2 m</p> | 78010-2 | 78021-2 | 78022-2 | 78023-2 |
|  | Mini trunking with divider 2 m | | | | |

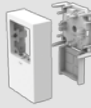
Adapters for switches and sockets in **U24X**

| | | | | |
|---|--|--|--|----------------|
|  | Adapter for 1 universal outlet | | | 78740-2 |
|  | Adapter for 2 universal outlets | | | 78741-2 |
|  | Adapter for 1 Simon* 73 loft | | | 78860-2 |
|  | Adapter for 1 Oteo* outlet | | | 78870-2 |

* These brands belong to third parties, they are not related to Unex aparellaje eléctrico, S.L.



| | 16x16 | 16x30 | 16x50 | 20x30 | 20x50 | 20x75 |
|--|-----------------------------------|-----------------|----------------|-----------------------------------|----------------|----------------|
| | | | | | | |
| | 78031-2 78031-04 | 78033-2 | | 78043-2 78043-04 | 78045-2 | |
| | 78031-2A | 78033-2A | | | | |
| | | 78083-2 | 78085-2 | 78093-2 | 78095-2 | 78147-2 |

| | | | | | |
|----------------|----------------|----------------|----------------|--|--|
| 78740-2 | | | | | |
| 78741-2 | | | | | |
| 78860-2 | 78862-2 | 78860-2 | 78862-2 | | |
| 78880-2 | | | 78890-2 | | |

See next page

Mounting of surface boxes in **U24X**

| | | Mini trunking sizes (mm) | | | | | | | | |
|--|--|--------------------------|---------|---------------------|----------------------|---------|---------|---------|---------|--|
| | | 10x22 | 10x30 | 16x16 | 16x30 | 16x50 | 20x30 | 20x50 | 20x75 | |
| | Mini trunking without divider (1 compartment) | 78022-2 78022-2A | 78023-2 | 78031-2 78031-2A | 78033-2 78033-2A | | 78043-2 | 78045-2 | | |
| | Mini trunking with 1 divider (2 compartments) | | | | 78083-2 | 78085-2 | 78093-2 | 78095-2 | | |
| | Mini trunking with 2 dividers (3 compartments) | | | | | | | | 78147-2 | |
| | Side adapter | 78622-2 | 78623-2 | 78631-2 | 78633-2 | 78635-2 | 78643-2 | 78645-2 | 78647-2 | |
| | Front adapter | 78672-2 | 78673-2 | 78681-2 | 78683-2 | | 78693-2 | | | |
| | Simón* 27 box | 78757-2 | | | | | | | | |
| | Mosaic* box | 78756-2 | | | | | | | | |
| | Universal Note: 2 screws and 1 cover part no. 7850-2 are included. | 78759-2 | | | | | | | | |
| | Modular box 4 outlets Note: 4 Trunking plugs part no. 25106 included. | | | | 85023-2 | | | | | |
| | Adapters for switches and sockets | | | | See table next page. | | | | | |
| | Modular box 6 outlets Note: 4 Trunking plugs part no. 25106 included. | | | | 85033-2 | | | | | |
| | Adapters for switches and sockets | | | | See table next page. | | | | | |
| | Modular box 8 outlets Note: 4 Trunking plugs part no. 25106 included. | | | | 85043-2 | | | | | |
| | Adapters for switches and sockets | | | | See table next page. | | | | | |

Universal adaptation of the Flexible runway 51 in **U24X** (See Furniture supply 51)

| | | | | | | | | | | |
|--|--|---------|--|--|--|--|--|--|--|--|
| | Universal adapter for Flexible runway 51 | 51630-2 | | | | | | | | |
| | Adapter for 1 Universal CEE-7 outlet | 78740-2 | | | | | | | | |
| | Modular adapter for Flexible runway 51 | 51623-2 | | | | | | | | |
| | Modular box 4 outlets | 85023-2 | | | | | | | | |
| | Modular box 6 outlets Note: 4 Trunking plugs part no. 25106 included. | 85033-2 | | | | | | | | |
| | Modular box 8 outlets | 85043-2 | | | | | | | | |

Socket box cover in **U24X**

| | | | | | | | | | | |
|--|------------------|---------|--|--|--|--|--|--|--|--|
| | Socket box cover | 78650-2 | | | | | | | | |
|--|------------------|---------|--|--|--|--|--|--|--|--|

*These brands belong to third parties; they are not related to Unex aparellaje eléctrico, S.L.

Adapters for Modular boxes 85

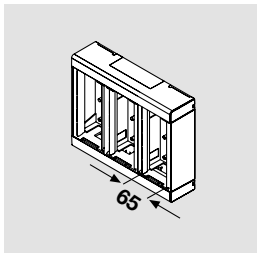

4 outlets

6 outlets

8 outlets

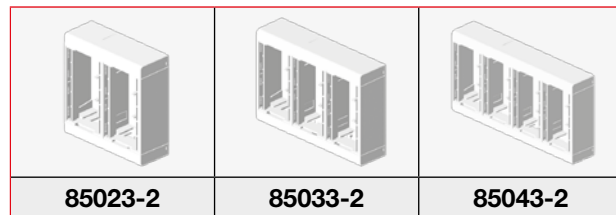

Single plate RJ45

| | | |
|--|--------------|--------------------|
| | Flat 1RJ45 | 93749-2 (1) |
| | Flat 2RJ45 | 93751-2 (1) |
| | Angled 2RJ45 | 93753-2 (2) |

Single adapter

| | | |
|--|------------------------|--------------------|
| | Niessen Zenit* | 93635-2 (3) |
| | BJC* Sol | 93663-2 |
| | Simon* 27 | 93621-2 |
| | Simon Connect* K45 | 93608-2 (4) |
| | Mosaic* and compatible | 93608-2 |
| | Eunea Unica* | 93653-2 |

Double adapter + |

| | | |
|--|------------------------|--------------------|
| | Simon CIMA 500* | 93640-2 |
| | Simon Connect* K45 | 93613-2 (4) |
| | Mosaic* and compatible | 93613-2 |
| | Eunea Unica* | 93656-2 |

Adapter DIN

| | |
|--|----------------|
| | 93648-2 |
|--|----------------|

(1) Compatible with RJ45 Systimax solutions and Universal type Keystone (AMP, Krone, Nexans, Jetlan, Belden, Brand-Rex and OPENETICS). For specific types or brands, please contact us.

(2) Compatible with RJ45 Universal type Keystone (AMP, Krone, Nexans, Jetlan, Belden, Brand-Rex and OPENETICS). For specific types or brands, please contact us.

(3) The adapters for Niessen Zenit outlets are designed for horizontal mounting. Vertical mounting cases, outlets will be turned 90° from original position.

(4) Most of the switches and sockets of K type are compatible with this adapter. However, there are some part numbers (for example KB076, KB76, K130A, 2u. KA76, 2u. K302 + K115, etc.) that can only be mounted on the double plate 93613-2 in the central area, placing blind lids on the sides.







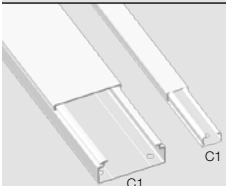

*These brands belong to third parties; they are not related to Unex aparellaje eléctrico, S.L.

See next page







Useful cross-sections (mm²)

Recommended capacity with conductors H07V-K

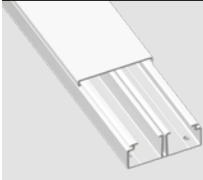

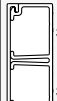
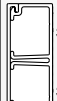

Sizes (mm) 7x12 10x16 10x22 10x30 16x16 16x30 16x50 20x30 20x50 20x75

| Part no. |  RAL 9010 / RAL 7035 | 78010-2 78010-2A | 78021-2 78021-2A | 78022-2 78022-2A | 78023-2 | 78031-2 78031-2A 78031-04 | 78033-2 78033-2A | | 78043-2 78043-04 | 78045-2 | |
|---|---|--|---|---|---|---|---|--|---|---|--|
|  | |  46 |  100 |  143 |  205 |  150 |  323 | |  437 |  764 | |
| Compartments | | C1 | C1 | C1 | C1 | C1 | C1 | | C1 | C1 | |
| Quantity of recommended conductors type H07V-K | 1.5 mm ² | 2 | 4 | 6 | 9 | 6 | 14 | | 18 | 32 | |
| | 2.5 mm ² | 1 | 3 | 4 | 6 | 4 | 9 | | 12 | 21 | |
| | 4 mm ² | 1 | 2 | 3 | 4 | 3 | 7 | | 9 | 17 | |
| | 6 mm ² | | 1 | 2 | 3 | 2 | 4 | | 5 | 10 | |

Sizes (mm) 7x12 10x16 10x22 10x30 16x16 16x30 16x50 20x30 20x50 20x75

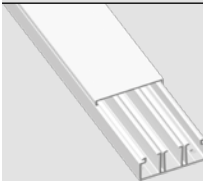
| Part no. |  RAL 9010 | | | | | | | | 78083-2 | 78085-2 | 78093-2 | 78095-2 | |
|--|---|--|--|--|--|--|--|--|--|--|--|--|--|
|  | | | | | | | | |  136  136 |  262  262 |  184  184 |  343  343 | |
| Compartments | | | | | | | | | C1 C2 | C1 C2 | C1 C2 | C1 C2 | |
| Quantity of recommended conductors type H07V-K | 1.5 mm ² | | | | | | | | 6 6 | 11 11 | 8 8 | 14 14 | |
| | 2.5 mm ² | | | | | | | | 4 4 | 7 7 | 5 5 | 9 9 | |
| | 4 mm ² | | | | | | | | 3 3 | 6 6 | 4 4 | 7 7 | |
| | 6 mm ² | | | | | | | | 2 2 | 3 3 | 2 2 | 4 4 | |

Sizes (mm) 7x12 10x16 10x22 10x30 16x16 16x30 16x50 20x30 20x50 20x75

| Part no. |  RAL 9010 | | | | | | | | | | | | 78147-2 |
|---|---|--|--|--|--|--|--|--|--|--|--|--|---|
|  | | | | | | | | | | | | |  337  345  337 |
| Compartments | | | | | | | | | | | | | C1 C2 C3 |
| Quantity of recommended conductors type H07V-K | 1.5 mm ² | | | | | | | | | | | | 14 15 14 |
| | 2.5 mm ² | | | | | | | | | | | | 9 10 9 |
| | 4 mm ² | | | | | | | | | | | | 7 8 7 |
| | 6 mm ² | | | | | | | | | | | | 4 4 4 |



COPYRIGHT: All trademarks, brands or distinctive signs, of any kind, that might appear in the present website are the property of Unex aparellaje eléctrico, S.L. or of third parties. The use or access to the present website and/or to its services should not be interpreted, under no circumstances, as conferring any rights to the User on the mentioned trademarks, brands or distinctive signs.

Furthermore, all Contents are the property of Unex aparellaje eléctrico, S.L. or of third parties. As stated in the mentioned Legal Notice, none of the operation rights existing or that might exist about the mentioned Contents should be understood as transferable to the User, beyond those strictly necessary for the correct use of the Portal and the Services.

