



Power supply
system for
work spaces

Service post 50

raw material

U24X

colour

Grey

Anthracite

For supply of work spaces from the floor in open-plan rooms

- Flexible modules enabled to properly lodge the required switches and sockets within a minimum of space, fitting well with the furniture distribution.
- **Innovatory, functional and minimalist design**, created to coexist with all kinds of settings.
- Solid and safe structures, easy to install and to relocate.

Raw material





Service post



Compliant

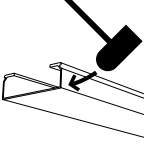
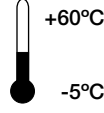
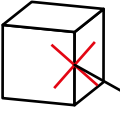

Technical characteristics

Electrical	Mechanical	Temperature	Protection degree	In front of fire
				
EN 50085-2-4*	EN 50085-2-4*	EN 50085-2-4*	EN 50085-2-4*	
Insulating material. <hr/> No earthing required.	IK07.		IP4X.	Glow-wire test at 960°C. <hr/> Non flame propagating.

* BS EN 50085-2-4 is the UK implementation of EN 50085-2-4.



Colour

Grey

RAL 7035

Anthracite

Quality marks



Conformity declaration



See updated technical
information of each
part number on
www.unex.net



Sports facilities: fitness center



Work spaces: office



Work spaces: office



Recreational and cultural facilities



Public service building: office



Work spaces: office

Supply options

From the floor



From technical floor

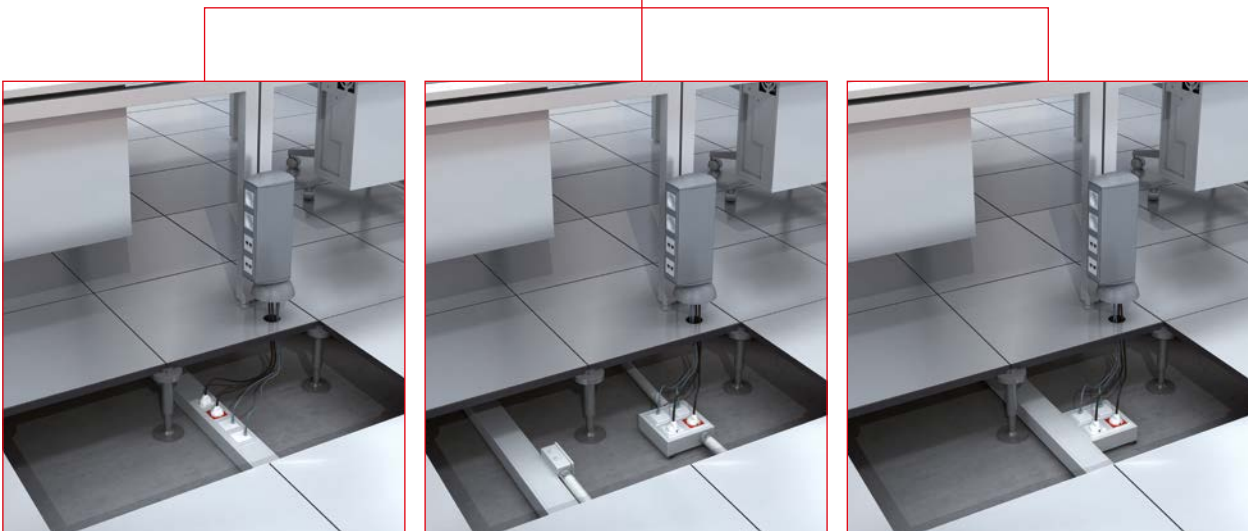

Mounting of switches and sockets

Safe and easy installation

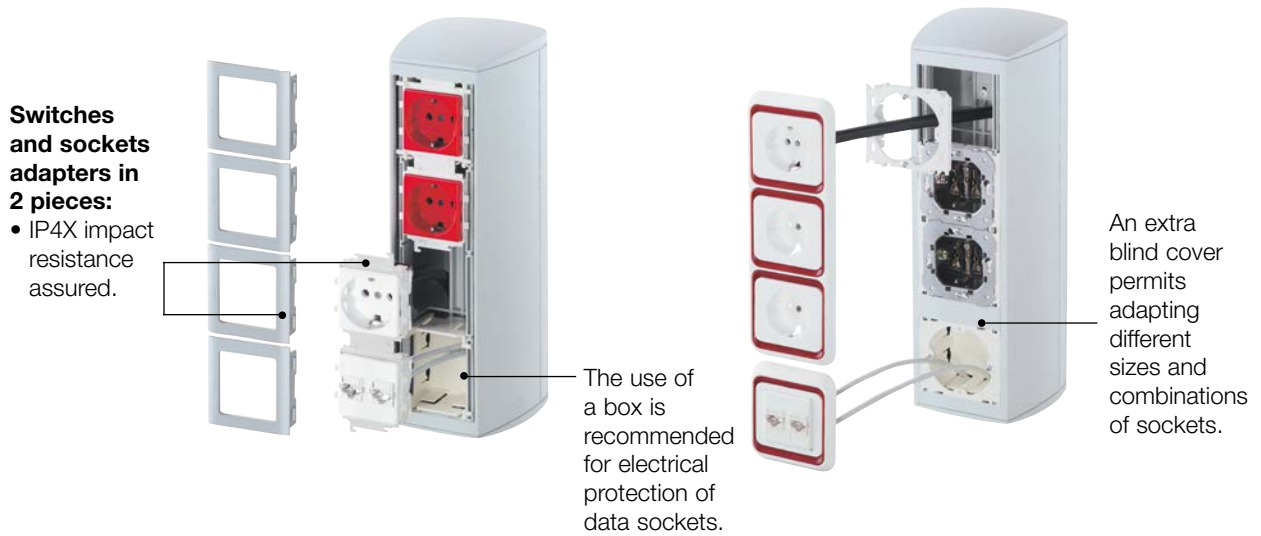

A system adapted to each work space



One-face service post has 4 outlets. You can choose them from these 2 colours:

- Grey RAL 7035.
- Anthracite.

Two-face service post have 8 outlets. You can choose them from these 2 colours:

- Grey RAL 7035.
- Anthracite.

Two-face service post have 16 outlets in colour:

- Grey RAL 7035.

Flexibility to combine a variety of switches and sockets

Electrical outlets

Universal CEE-7 (1)



- Niessen* Olas, Arco, Tacto, Zenit and Stylo.
- BJC*.
- Jung*.
- Simon* 31, 75, 88, 82.
- Mosaic*.
- Valena*.
- Bticino*.
- Eunea*.
- Berker*.
- Gewiss*.

Industrial socket box



- Mennekes*.
- ABL*.
- Simon*.

Modular



- Niessen Zenit*.
- Simon* 27.
- Simon Connect* K45 and compatible.
- Mosaic*.
- Eunea Unica*.
- BJC Sol*.

Modular double



- Mosaic*.
- Simon Connect* K45 "linkable".
- Eunea Unica*.
- Simon CIMA 500*.

Modular triple



- Simon Connect* K45 "linkable".
- Mosaic*.

Universal



- Niessen* Zenit.
- Bticino*.
- Unica-Allegro* (3 modules).
- Gewiss*.

DIN (Bipolar)



- MCB's (Miniature circuit breakers).
- RCD's (Residual current devices).

Data connectors

Flat plate 1 RJ45



- Compatible with:
- Systemax solutions.
 - Universal type Keystone.

Flat plate 2 RJ45



- Compatible with:
- Systemax solutions.
 - Universal type Keystone.

Angled plate 2 RJ45



- Compatible with:
- Universal type Keystone.

Mounting of 5 modular outlets in a socket box 80 mm

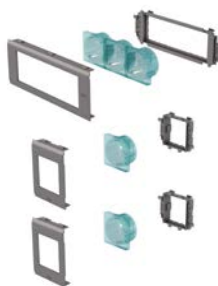

1 triple adapter +
2 single adapters



1 triple adapter +
1 double adapter

Reduced stock of fittings. Same system for mounting switches and sockets for: Trunking 93, Modular box 85, Service pole 50, Service post 50 and Furniture supply 51

(1) It is not possible to mount 4 simple adapters; possible combinations: 1+3, 2+2 or 1 adapter for 4 outlets.

* These brands belong to third parties; they are not related to Unex aparellaje eléctrico, S.L.

Easy and comfortable mounting

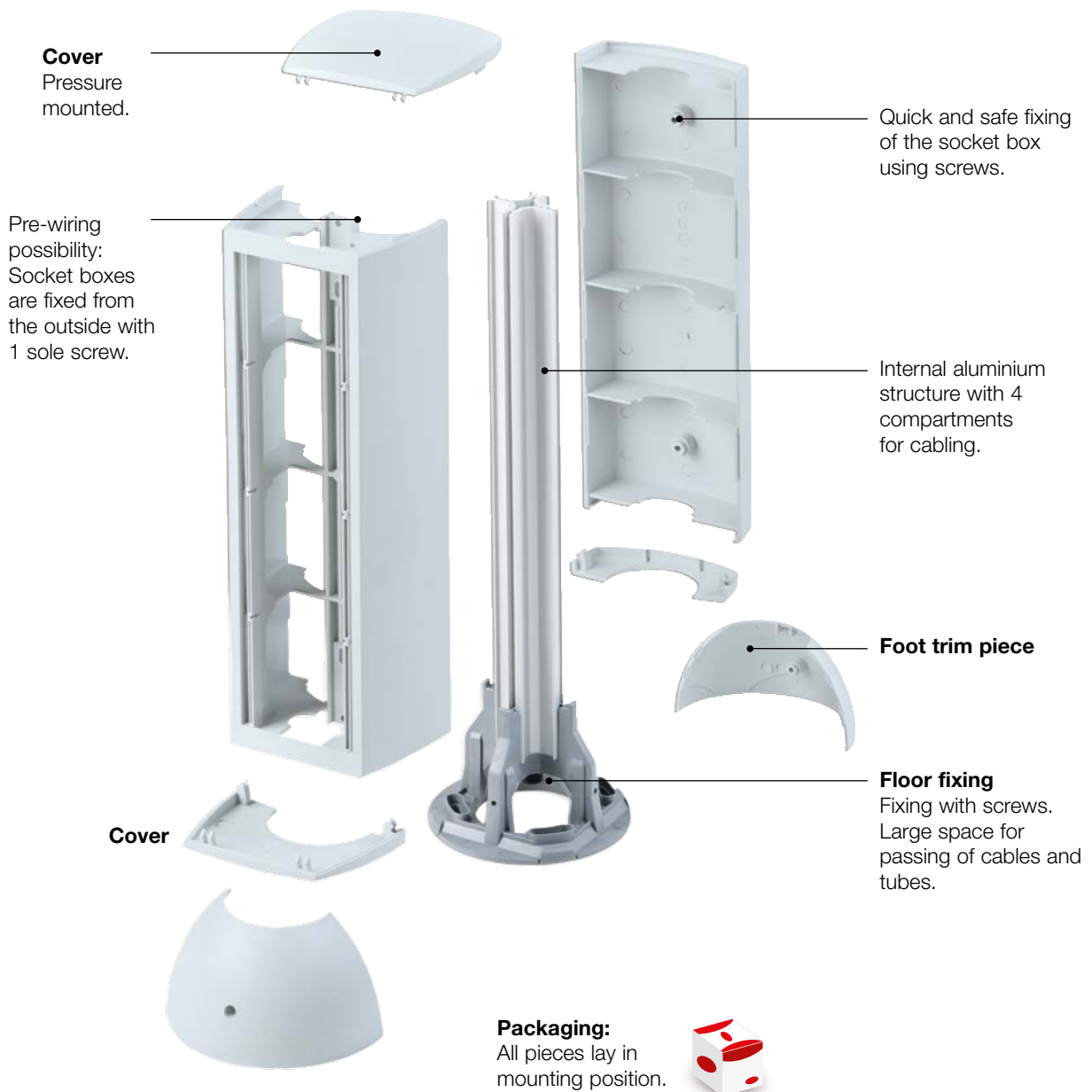

Switches and sockets width (mm)

65

80

	<p>Grey RAL 7035 (Part no. 50xxx)</p> <p>Anthracite (Part no. 50xxx-05)</p>		
	<p>Service post 4 outlets To install 4 switches and sockets.</p>	50623	50624
		50623-05	50624-05
	<p>Service post 8 outlets To install 4 switches and sockets on each side.</p>	50723	50724
		50723-05	50724-05
	<p>Service post 16 outlets To install 8 switches and sockets on each side.</p>	50743	50744
	Adapters	Essential to mount switches and sockets (See table pages 218-219).	

Mounting of Service post on Floor box 52 in U24X (See Floor Box 52)

	Floor box	52802
--	------------------	--------------

Flexible runway 51 adapters in U24X (See Furniture supply 51)

	<p>White RAL 9010 (Part no. 51xxx-2)</p> <p>Aluminium RAL 9006 (Part no. 51xxx-03)</p>		
	<p>Modular adapter for Flexible runway 51</p>	51623-2	51624-2
		51623-03	51624-03

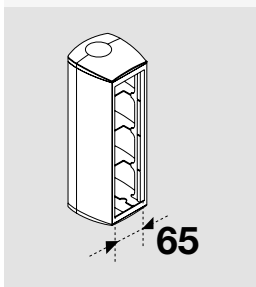

See next page

Adapters for service posts socket boxes 65 mm. width



White RAL 9010 (Part no. 93xxx-2)
Aluminium RAL 9006 (Part no. 93xxx-03)

Service post 4 outlets Service post 8 outlets Service post 16 outlets

		
50623 50623-05	50723 50723-05	50743

Single plate RJ45



Flat 1RJ45	93749-2 (1)	93749-03 (1)
Flat 2RJ45	93751-2 (1)	93751-03 (1)
Angled 2RJ45	93753-2 (2)	93753-03 (2)

Single adapter

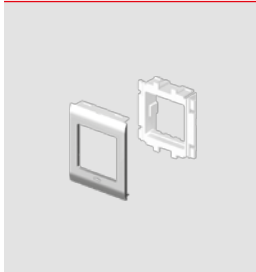

Niessen Zenit*	93635-2 (3)	93635-03 (3)
BJC* Sol	93663-2	93663-03
Simon* 27	93621-2	93621-03
Simon Connect* K45	93608-2 (4)	93608-03 (4)
Mosaic* and compatible	93608-2	93608-03
Eunea Unica*	93653-2	93653-03

Double adapter + |

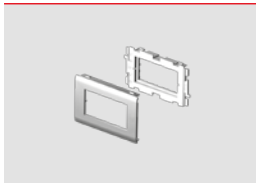

Simon Connect* K45	93613-2 (4)	93613-03 (4)
Mosaic* and compatible	93613-2	93613-03
Eunea Unica*	93656-2	93656-03
Simon CIMA 500*	93640-2	93640-03

Adapter DIN (5)



93648-2	93648-03
----------------	-----------------

Socket boxes (6)



Single adapter **Double adapter**

93713	93718
--------------	--------------

(1) Compatible with RJ45 Systimax solutions and Universal type Keystone (AMP, Krone, Nexans, Jetlan, Belden, Brand-Rex and OPENETICS). For specific types or brands, please contact us.
(2) Compatible with RJ45 Universal type Keystone (AMP, Krone, Nexans, Jetlan, Belden, Brand-Rex and OPENETICS). For specific types or brands, please contact us.
(3) The adapters for Niessen Zenit outlets are designed for horizontal mounting. In vertical mounting cases, outlets will rotate 90° degrees from their original position.
(4) Most of the switches and sockets of K type are compatible with this adapter. However, there are some part numbers (for example KB076, KB76, K130A, 2u. KA76, 2u. K302 + K115, etc.) that can only be mounted on the double plate 93613-2/93613-03.
(5) For electrical outlets DIN the box 93718 is necessary to fix the outlet to the service post.
(6) The use of the box is necessary to assure the separation of circuits.
*These brands belong to third parties; they are not related to Unex aparellaje eléctrico, S.L.

See next page 

Adapters for the service pole's socket boxes 80 mm. width

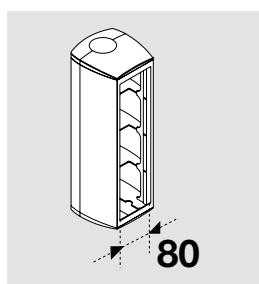

White RAL 9010 (Part no. 93xxx-2)

Aluminium RAL 9006 (Part no. 93xxx-03)

Service post 4 outlets Service post 8 outlets Service post 16 outlets

50624 50624-05	50724 50624-05	50744



Universal single adapter (1)

	Universal CEE-7	93604
	Universal outlet box	93709

Single industrial outlet box (2)

		93708
--	--	--------------

Single plate RJ45

	Flat 1RJ45	93750-2 (3)	93750-03 (3)
	Flat 2RJ45	93752-2 (3)	93752-03 (3)
	Angled 2RJ45	93754-2 (4)	93754-03 (4)

Single adapter

	Niessen Zenit*	93636-2 (5)	93636-03 (5)
	BJC* Sol	93664-2	93664-03
	Simon* 27	93622-2	93622-03
	Simon Connect* K45	93609-2 (6)	93609-03 (6)
	Mosaic* and compatible	93609-2	93609-03
	Eunea Unica*	93654-2	93654-03

Double adapter |

	Simon CIMA 500*	93641-2	93641-03
	Simon Connect* K45	93614-2 (6)	93614-03 (6)
	Mosaic* and compatible	93614-2	93614-03
	Eunea Unica*	93657-2	93657-03
	Universal	93644-2 (7)	93644-03 (7)

Triple adapter | |

	Simon Connect* K45	93619-2 (6)	93619-03 (6)
	Mosaic* and compatible	93619-2	93619-03

Adapter DIN (8)

		93649-2	93649-03
--	--	----------------	-----------------

Socket boxes (9)

	Single adapter	Double adapter	Triple adapter
--	----------------	----------------	----------------

	93714	93719 (10)	93729 (10)
--	--------------	-------------------	-------------------

- (1) Frames shall be supplied by the socket manufacturer. We recommend frames with straight corners.
 - (2) Box for industrial outlets, compatible with some outlets from Mennekes brand and others. Can be installed 3 outlets per module. Please contact us for details.
 - (3) Compatible with RJ45 Systimax solutions and Universal type Keystone (AMP, Krone, Nexans, Jetlan, Belden, Brand-Rex and OPENETICS). For specific types or brands, please contact us.
 - (4) Compatible with RJ45 Universal type Keystone (AMP, Krone, Nexans, Jetlan, Belden, Brand-Rex and OPENETICS). For specific types or brands, please contact us.
 - (5) The adapters for Niessen Zenit outlets are designed for horizontal mounting. In vertical mounting cases, outlets will rotate 90° degrees from their original position.
 - (6) Most of the switches and sockets of K type are compatible with this adapter. However, there are some part numbers (for example KB076, KB76, K130A, 2u. KA76, 2u. K302 + K115, etc.) that can only be mounted on the double plate 93614-2/93619-03 or on the triple plate 93619-2/93619-03 in the central area, placing blind lids on the sides.
 - (7) 1, 2 or 3 outlets of 25mm. module can be installed.
 - (8) For electrical outlets DIN, the box 93719 is necessary to fix the outlet to the service post.
 - (9) The use of the box is necessary to assure the separation of circuits.
 - (10) Includes a divider part no. 93720 to separate circuits in connections. It can also be sold individually.
- *These brands belong to third parties; they are not related to Unex aparellaje eléctrico, S.L.

Useful cross-sections for wiring

Wiring example

Service post

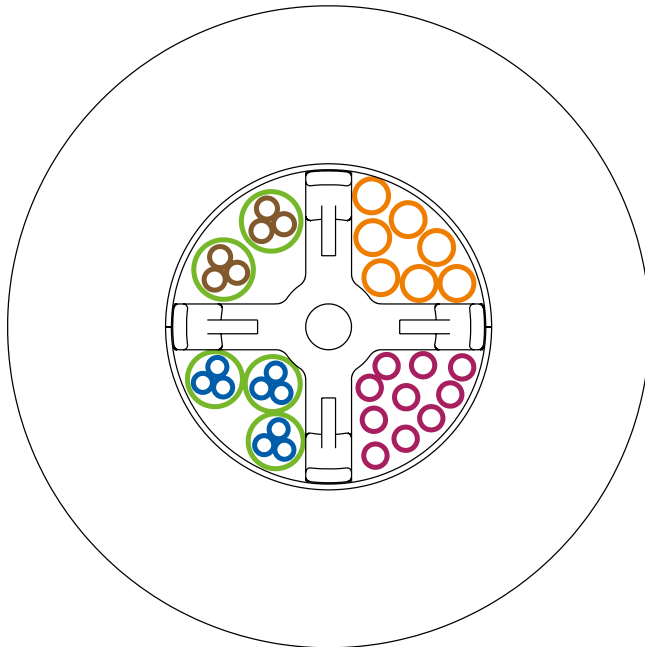

Data cables:

- 7 pcs. cable STP 4 pairs. Maximum Ø7.4 mm.
- 10 p. UTP 4 pairs. Maximum Ø5.1 mm.

Power cables:

- ⊗ 2 pcs. 0.6/1kV RV-K 3G2.5. Maximum Ø13 mm.
- ⊗ 3 pcs. 0.6/1kV RV-K 3G2.5. Maximum Ø12 mm.

Sizes

For fixing the service post without a floor box

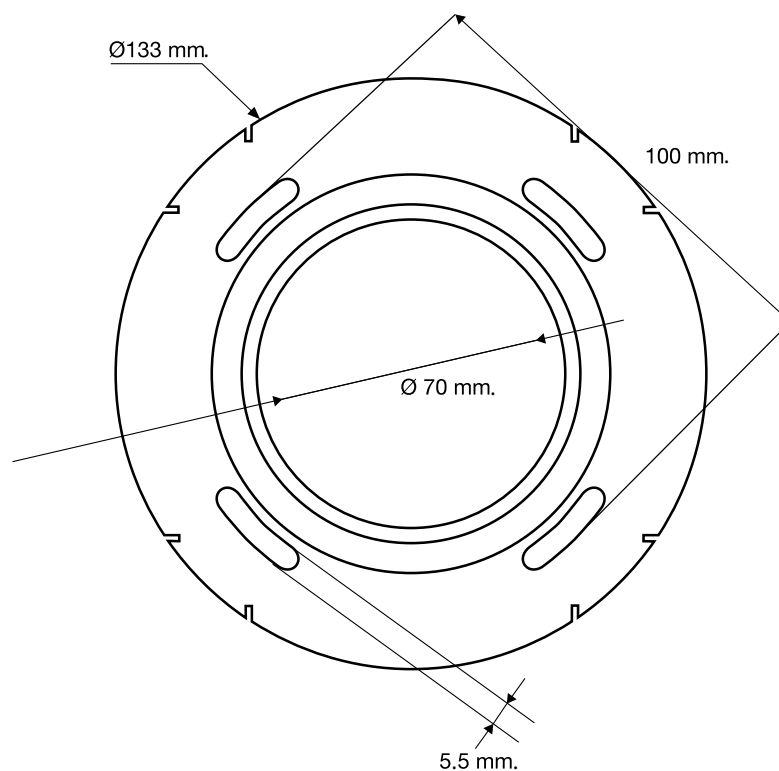

COPYRIGHT: All trademarks, brands or distinctive signs, of any kind, that might appear in the present website are the property of Unex aparellaje eléctrico, S.L. or of third parties. The use or access to the present website and/or to its services should not be interpreted, under no circumstances, as conferring any rights to the User on the mentioned trademarks, brands or distinctive signs.

Furthermore, all Contents are the property of Unex aparellaje eléctrico, S.L. or of third parties. As stated in the mentioned Legal Notice, none of the operation rights existing or that might exist about the mentioned Contents should be understood as transferable to the User, beyond those strictly necessary for the correct use of the Portal and the Services.

