



Cable conduction  
and protection  
system

# Trunking

# 73

raw material

**U23X**

colour

**Grey**

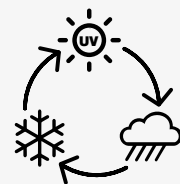

## For distribution and machinery supply

- **Suitable for outdoor use.**
- Complete range with all necessary fittings offering more rigidity and safety throughout the mounting process.
- Homogeneity with the rest of the installation's elements.
- For conduction and protection of power and communication cables.

## Raw material

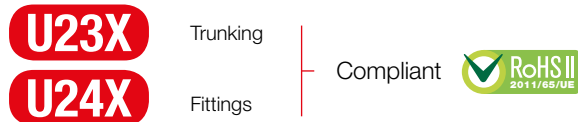

## Technical characteristics

<p><b>Electrical</b></p> <p><b>EN 50085-2-1*</b></p> <p>Insulating material. No earthing required.</p>	<p><b>Mechanical</b></p> <p><b>EN 50085-2-1*</b></p> <p>IK08 (except mini trunkings height &lt; 30 mm: IK07).</p>	<p><b>Service temperature</b></p> <p><b>EN 50085-2-1*</b></p> <p>Mini trunkings height &lt; 30 mm: -5°+60°C.</p>	<p><b>Protection degree</b></p> <p><b>EN 50085-2-1*</b></p> <p>IP4X, mounted on the wall.</p>	<p><b>Corrosion</b></p> <p><b>ISO/TR 10358 DIN 8061</b></p> <p>Good resistance to corrosion and to chemical agents.</p>
<p><b>Outdoors</b></p> <p>Good performance outdoors and with exposure to UV rays. (Except trunkings height &lt; 30 mm).</p>	<p><b>In front of fire</b></p> <p>Glow-wire test 960°C. Non flame propagating. Reaction to fire, Class M1 acc./UNE 201010. Flammability degree UL94: V0. Does not spread fire by dripping.</p>			

\* BS EN 50085-2-1 is the UK implementation of EN 50085-2-1.

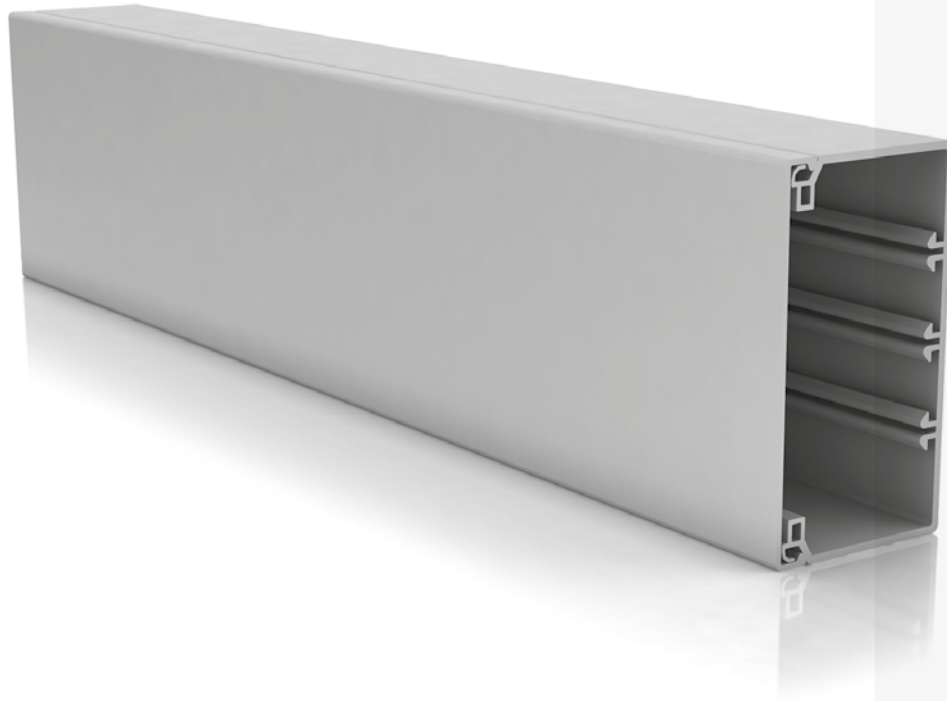

Length

**2 and 3 m**

Colour

**Grey****RAL 7035**

## Quality marks



## Approvals



Bureau Veritas

Φ3 от 22.07.08 N 123-Φ3  
ГОСТ P 53313-2009

Iberdrola NI 52.40.02

See updated technical  
information of each  
part number on  
[www.unex.net](http://www.unex.net)

## Conformity declaration





Photovoltaics



Chemical industry



Housing



Apartment building renovation

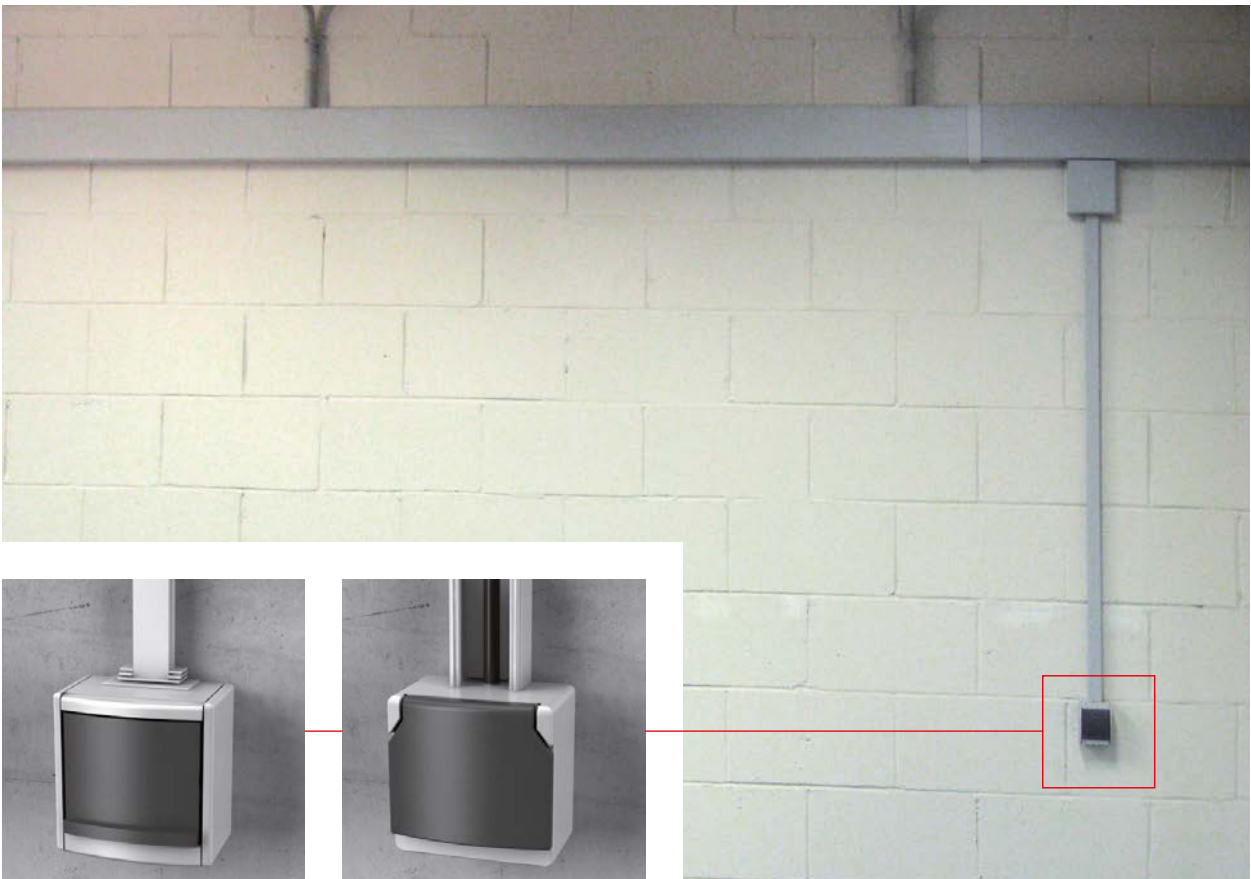

Industry: mounting of outlets

## Easy installation

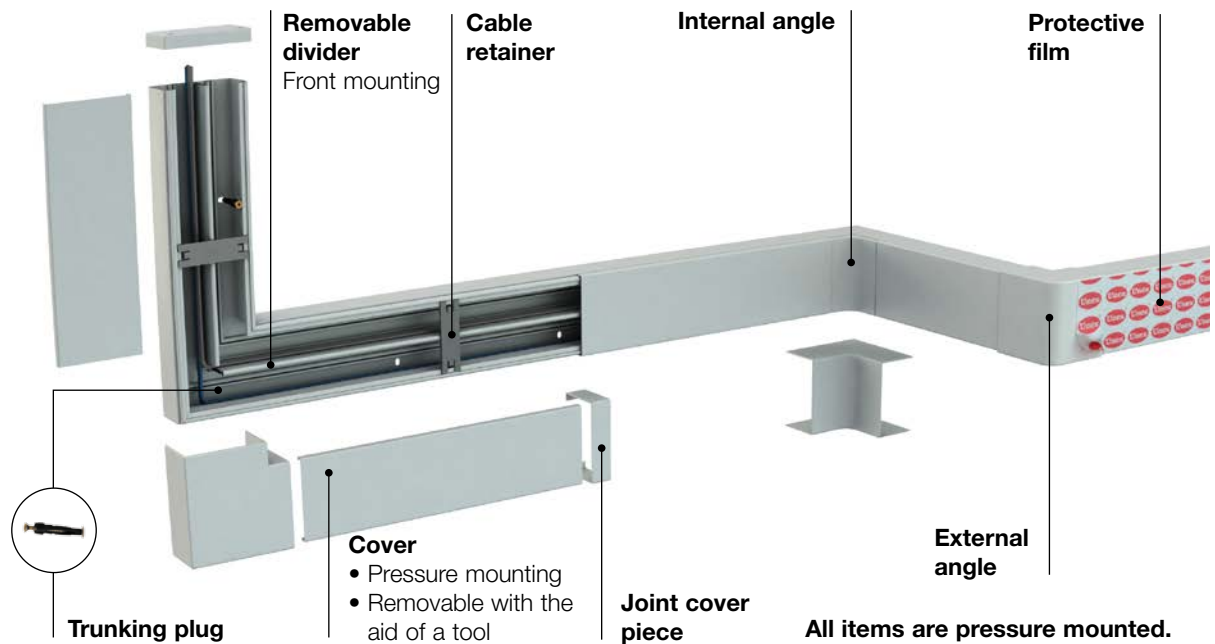

### Fittings in 2 pieces



- **The internal piece** allows easy measuring of the cover and holds the cables.
- **The external piece** covers the cut marks of base and cover. It is not necessary to slide the cover. Assures protection degree IP4X.

### Protection of data cables

Firm holding of the cover:  
removable with the aid of a tool

#### Corner-pieces



Allows you to keep the right bending radius: reliability of the signal transmitted.

#### Cable retainer



Retains the cables. Ensures the fixing of the cover in the most demanding cases: impact resistance vertical posts, inverted mountings, etc.

# The trunking as continuous connection box

Surface mounting using a 750V conductor



## Possibility to mount with terminal blocks

Surface mounting

With trunkings 60x60 or bigger, it is possible to make connections with terminal blocks, without the need to place an enclosure.







## Circuit separation

Possibility to mount insulating dividers in trunkings of 40x60 or bigger. Conductors are insulated according to their voltage in a compartment that assures the level of insulation required for the maximum voltage on the installation.





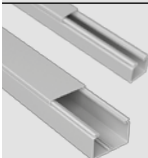



**Insulating trunking + Insulating divider**  
Guarantees the level of insulation required.

		Trunking sizes (mm)	16x16	20x30	30x40	40x40
<div style="border: 1px solid black; border-radius: 10px; padding: 5px; display: inline-block;">Grey</div> RAL 7035 (Part no. 73xxx-04 and 78xxx-04)						
Maximum number of compartments			1	1	1	1
	<b>Mini trunking</b> L = 2 m <hr/> <b>Trunking</b> Note: 1 cable retainer every 0,5 m is included.      L = 3 m	<b>78031-04</b>	<b>78043-04</b>			
				<b>73010-04</b>	<b>73020-04</b>	

### Accessories in U23X

	<b>Divider</b> L = 3 m				
---	------------------------	--	--	--	--



### Fittings in U24X

	<b>Flat angle</b>	<b>78231-04</b>	<b>78243-04</b>	<b>73210-04</b>	<b>73220-04</b>
	<b>External angle</b>	<b>78281-04</b>	<b>78293-04</b>	<b>73260-04</b>	<b>73270-04</b>
	<b>Internal angle</b>	<b>78331-04</b>	<b>78343-04</b>	<b>73310-04</b>	<b>73320-04</b>
	<b>End cover</b>	<b>78381-04</b>	<b>78393-04</b>	<b>73360-04</b>	<b>73370-04</b>
	<b>Joint cover piece</b>	<b>78531-04</b>	<b>78543-04</b>	<b>73510-04</b>	<b>73520-04</b>
	<b>Connection and branch box</b> 110x110x45 mm	<b>78457-04</b>			
	110x150x74 mm	<b>73461-04</b>			

### Cable protection elements in U24X

	<b>Corner-piece flat angle</b>			<b>73880</b>
	<b>Corner-piece external angle</b>			

### Other accessories in U24X

	<b>Cable retainer</b> Note: 1 cable retainer every 0,5 m is included.			
				<b>73850</b>
	<b>Junction</b>			

### Fixing elements in U63X

	<b>Trunking plug</b> Indoor use	<b>25104</b>	<b>25106</b>
---	---------------------------------	--------------	--------------

(1) The part numbers 73071-04, 73081-04, 73083-04, 73085-04 include 2 junctions for each trunking length.



40x60

60x60

60x90

60x110

60x150

60x190

60x230



2	1	2	4	4	6	6
<b>73071-04 (1)</b>	<b>73081-04</b>	<b>73082-04 (1)</b>	<b>73083-04 (1)</b>	<b>73085-04 (1)</b>	<b>73086-04</b>	<b>73088-04</b>

<b>73820</b>		<b>73830</b>
--------------	--	--------------

<b>73221-04</b>	<b>73231-04</b>	<b>73232-04</b>	<b>73233-04</b>	<b>73235-04</b>	<b>73236-04</b>	<b>73238-04</b>
<b>73271-04</b>	<b>73281-04</b>	<b>73282-04</b>	<b>73283-04</b>	<b>73285-04</b>	<b>73286-04</b>	<b>73288-04</b>
<b>73321-04</b>	<b>73331-04</b>	<b>73332-04</b>	<b>73333-04</b>	<b>73335-04</b>	<b>73336-04</b>	<b>73338-04</b>
<b>73371-04</b>	<b>73381-04</b>	<b>73382-04</b>	<b>73383-04</b>	<b>73385-04</b>	<b>73386-04</b>	<b>73388-04</b>
<b>73521-04</b>	<b>73531-04</b>	<b>73532-04</b>	<b>73533-04</b>	<b>73535-04</b>	<b>73536-04</b>	<b>73538-04</b>
<b>73461-04</b>						

<b>73880</b>		
<b>93870</b>		<b>93870</b>

<b>73861-00</b>		<b>73862-00</b>	<b>73863-00</b>	<b>73865-00</b>		
	<b>70064</b>				<b>73856</b>	<b>73858</b>
<b>73571-00</b>		<b>73581-00</b>				







<b>25106</b>		
--------------	--	--

See next page

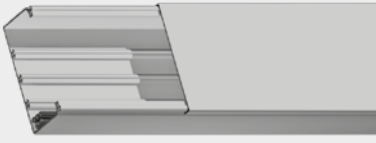
Useful cross-sections (mm<sup>2</sup>)

		Sizes (mm)			
		16x16	20x30	30x40	40x40
<b>Part no.</b>	Grey RAL 7035	<b>78031-04</b>	<b>78043-04</b>	<b>73010-04</b>	<b>73020-04</b>

**Distribution**

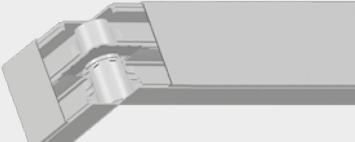
<b>Without divider</b>		 150	 437	 670	 1020
<b>With divider</b>					
<b>With divider and corner-piece</b>					

40x60

60x60

60x90

60x110

60x150

60x190

60x230

**73071-04**

**73081-04**

**73082-04**

**73083-04**

**73085-04**

**73086-04**

**73088-04**



1530



2713



3930



4780

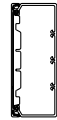

6540



8205



9930



705

705



1840

1840



1160

855

855

1160

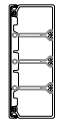

1595

1305

1305

1595

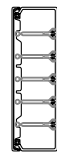

1345

1070

1070

1070

1070

1345

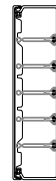

1790

1285

1285

1285

1285

1790



425

425



1415

1415



900

695

695

900

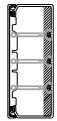

1230

1025

1025

1230

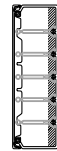

1040

850

850

850

850

1040



1380

1020

1020

1020

1020

1380

COPYRIGHT: All trademarks, brands or distinctive signs, of any kind, that might appear in the present website are the property of Unex aparellaje eléctrico, S.L. or of third parties. The use or access to the present website and/or to its services should not be interpreted, under no circumstances, as conferring any rights to the User on the mentioned trademarks, brands or distinctive signs.

Furthermore, all Contents are the property of Unex aparellaje eléctrico, S.L. or of third parties. As stated in the mentioned Legal Notice, none of the operation rights existing or that might exist about the mentioned Contents should be understood as transferable to the User, beyond those strictly necessary for the correct use of the Portal and the Services.