



Power supply
system for
work spaces

Trunking 93

raw material

U23X

colour

Aluminium



Designed to fit in the most demanding architectural and decorative surroundings

- Integration into the surroundings due to the aluminium finishing.
- **Free choice of switches and sockets.**
- Possibility to **attach or flush-mount** the trunking on walls and furniture.
- Standard product, immediate availability.

Raw material

U23X

Trunking



U24X

Fittings, accessories and switches and sockets adapters

Compliant

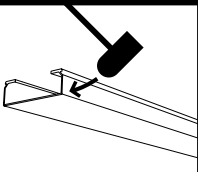
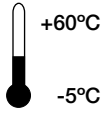
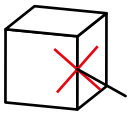

Technical characteristics

Electrical	Mechanical	Temperature	Protection degree	In front of fire
				
EN 50085-2-1*	EN 50085-2-1*	EN 50085-2-1*	EN 50085-2-1*	
<p>Insulating material.</p> <hr/> <p>No earthing required.</p>	<p>IK08 type 3 (distribution and mounting of switches and sockets).</p>		<p>IP4X, mounted on the wall.</p>	<p>Glow-wire test 960°C.</p> <hr/> <p>Non flame propagating.</p> <hr/> <p>Reaction to fire, Class M1 acc./UNE 201010.</p> <hr/> <p>Flammability degree UL94: V0. Does not spread fire by dripping.</p>

* BS EN 50085-2-1 is the UK implementation of EN 50085-2-1.



Length

2 m

Colour

Aluminium

RAL 9006

Quality marks



Approvals



Bureau Veritas

Φ3 от 22.07.08 N 123-Φ3
ГОСТ P 53313-2009See updated technical
information of each
part number on
www.unex.net

Conformity declaration





Work spaces: office



Health care



Work spaces: office



Work spaces: office



School

Use

Trunking as continuous box

Trunking allows to set the work spaces in any position to facilitate the extension and modification, depending on the user's needs.



Integration of the different types of installations in the same trunking.

Mounting options

On the wall or flush-mounted

Unex trunkings are designed for their mounting on the wall or flush-mounted on brick walls or plaster board, partitions, wooden linings, etc.



Skirting board



Windowsill



Embedded



Attached to the furniture

Safe and easy installation

Wiring accessories

Double-piece adapters:

- **Internal piece:** for a solid fixing to the base and easy measuring of the cover.
- **External and embellishing pieces:** hide the cover cut marks.
- IP4X protection against solid foreign objects.

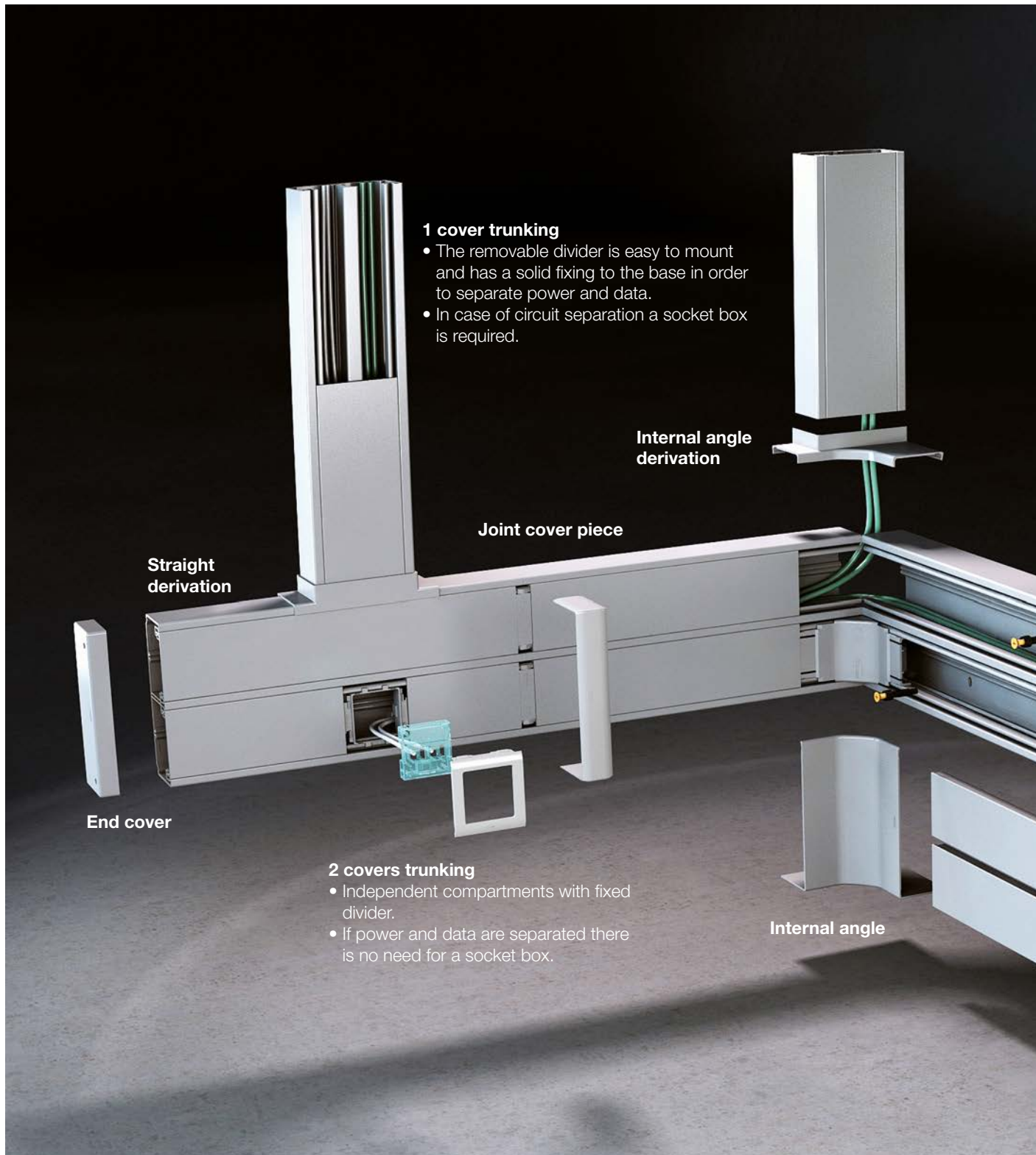

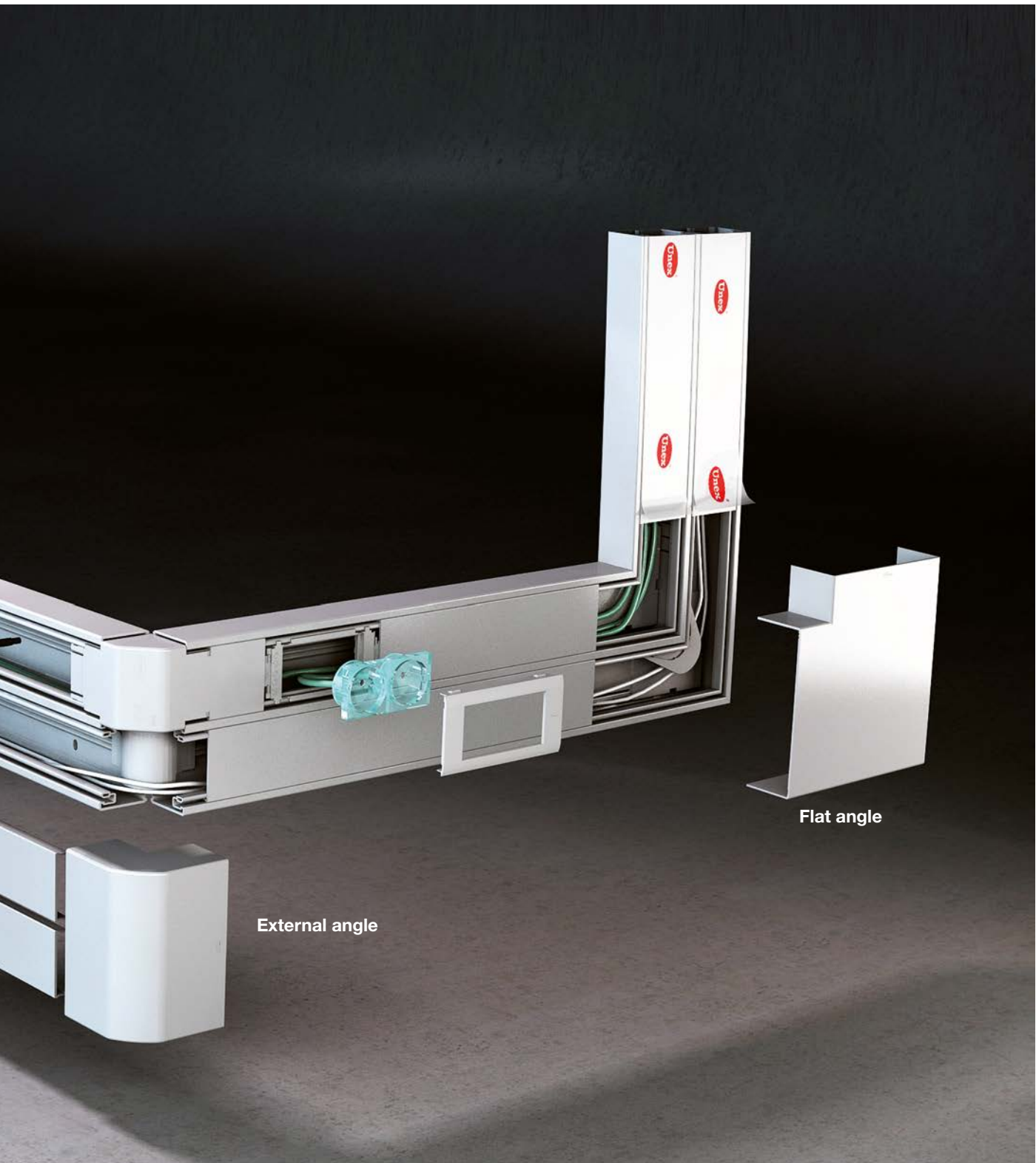

External angle

Flat angle

Mounting of switches and sockets

Safe installation

Double-piece adapters:

- **Internal piece:** for a solid fixing to the base and easy measuring of the cover.
- **External and embellishing pieces:** hide the cover cut marks.
- IP4X protection against solid foreign objects.

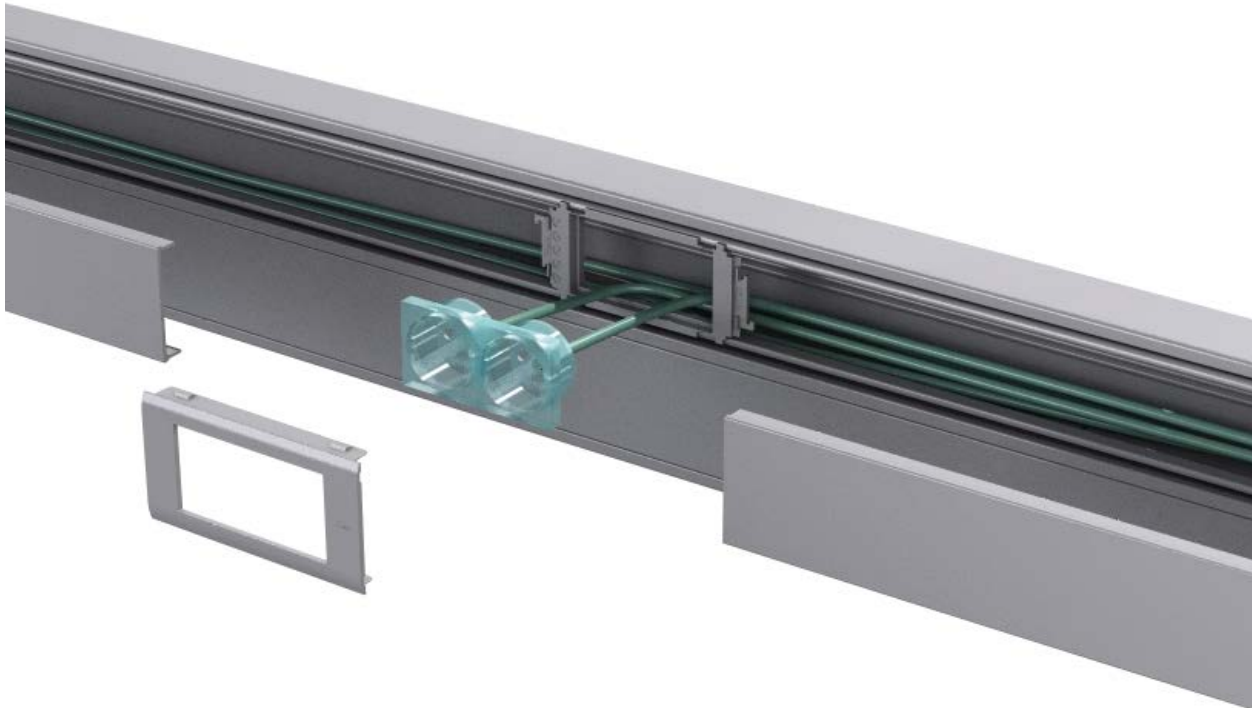

Flexibility to combine a variety of switches and sockets

Unex trunkings are designed to combine different types of installations: electrical, TV, audio-video, sound, data, security, control, etc.

Possibility of extension and evolution of the installations with no dependence on the type of outlet installed.



Flexibility to combine a variety of switches and sockets

Electrical outlets

Universal CEE-7



- Niessen* Olas, Arco, Tacto, Zenit and Stylo.
- BJC*.
- Jung*.
- Simon* 31, 75, 88, 82.
- Mosaic*.
- Bticino*.
- Eunea*.
- Berker*.
- Gewiss*.

Industrial socket box



- Mennekes*.
- ABL*.
- Simon*.

Modular



- Niessen Zenit*.
- Simon* 27.
- Simon Connect* K45 and compatible.
- Mosaic*.
- Eunea Unica*.
- BJC Sol*.

Modular double



- Mosaic*.
- Simon Connect* K45 "linkable".
- Eunea Unica*.
- Simon CIMA 500*.

Modular triple



- Simon Connect* K45 "linkable".
- Mosaic*.

Universal

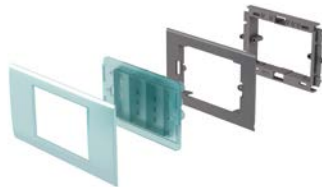

- Niessen* Zenit.
- Bticino*.
- Unica-Allegro* (3 modules).
- Gewiss*.

DIN (Bipolar)

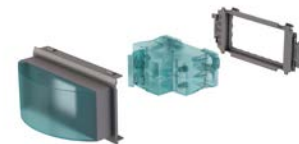

- MCB's (Miniature circuit breakers).
- RCD's (Residual current devices).

Data connectors

Flat plate 1 RJ45

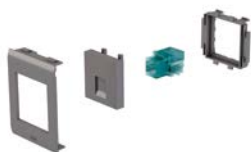

- Compatible with:
- Systemax solutions.
 - Universal type Keystone.

Flat plate 2 RJ45



- Compatible with:
- Systemax solutions.
 - Universal type Keystone.

Angled plate 2 RJ45



- Compatible with:
- Universal type Keystone.

* These brands belong to third parties; they are not related to Unex aparellaje eléctrico, S.L.

Safety

Electrical safety

Protection degree IP4X against solid foreign objects:

The system of adapters for Trunking 93 assures protection degree IP4X or IPXXD against solid foreign objects, acc./EN 50085-2-1.

**Resistance to wrenching:**

The adapters for power outlets resist 81N, in compliance with EN 50085-1 and European regulations of power outlets.

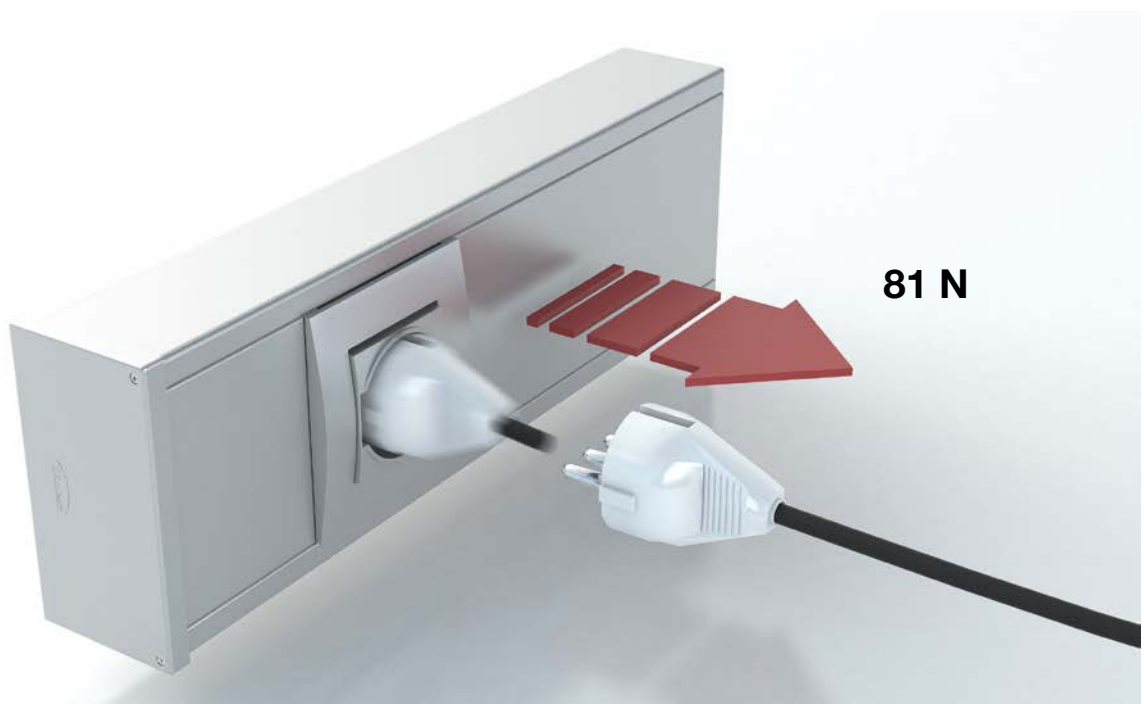

Safer installations

Trunking 70 mm, bigger bending radius:

- Allows the necessary bending radius for passing the data cables acc./EN 50174-2.
- Larger spare section for cable passing.

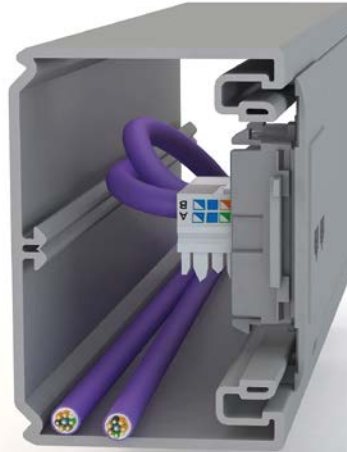

Protection of IT cables:



- Data cabling can keep the right bending radius according to EN 50174-2.



Circuit separation:

- Unex 2 lid cover trunking allows to separate cabling and outlets, making unnecessary the use of a socket box for this purpose.



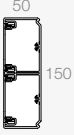
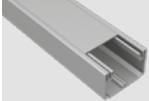









		Trunking sizes (mm)		50x80		50x100		50x150	
 Aluminium RAL 9006 (Part no. 93xxx-03)									
Cover sizes (mm)		65		80		65		65	
Maximum number of compartments		2		2		4			
	Trunking 2 m	93020-03		93021-03		93074-03			

Accessories in U23X

	Divider 2 m	93820			
---	-----------------------	-------	--	--	--

Fittings in U24X

	Flat angle	93220-03	93221-03	93224-03
	External angle	93270-03	93271-03	93274-03
	Internal angle	93320-03	93321-03	93324-03
	End cover	93370-03	93371-03	93374-03
	Joint cover piece	93520-03	93521-03	93524-03
	Straight derivation Branching to a 100 mm wide trunking	93421-03		
	Internal angle derivation Branching to a 100 mm wide trunking	93471-03		
	L Profile 2 m	U23X 93575-03		
	Floor strip 2 m	U23X White RAL 9010 93570-2		
	Floor strip external angle	White RAL 9010 93572-2		

70x100

70x130

70x170

70x210

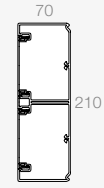
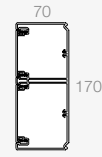
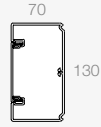
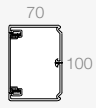

80

80

65

80

80

80

2

2

4

4

93031-03

93032-03

93086-03

93087-03

93830

93231-03

93232-03

93236-03

93237-03

93281-03

93282-03

93286-03

93287-03

93331-03

93332-03

93336-03

93337-03

93381-03

93382-03

93386-03

93387-03

93531-03

93532-03

93536-03

93537-03



93431-03

93575-2

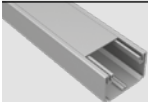

93580-2

93582-2

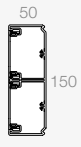
See next page

Trunking sizes (mm)		50x80	50x100	50x150	
	Aluminium RAL 9006 (Part no. 93xxx-03)				
Cover sizes (mm)		65	80	65	65
Maximum number of compartments		2	2	4	
Trunking 2 m		93020-03	93021-03	93074-03	

Cable protection elements in **U24X**

	Corner-piece flat angle	93880	
	Corner-piece external angle	93870	
	Divider protective piece		93862

Other accessories in **U23X**

	Junction	93550
---	----------	-------

Fixing elements in **U63X**

	Trunking plug Note: Use drill bit Ø6 mm.	25106
---	---	-------

Adapters for switches and sockets in **U24X**

	Adapter for switches and sockets	See table of adapters, according to the size of the cover. (See pages 126-127).
---	----------------------------------	--

Modular adaptation of the Flexible runway 51 in **U24X** (See Furniture supply 51)

	Modular adapter for Flexible runway 51	51623-03	51624-03	51623-03
---	--	----------	----------	----------

70x100

70x130

70x170

70x210

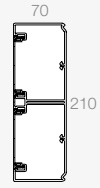
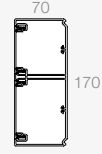
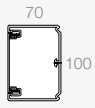

80

80

65

80

80

80

2

2

4

4

93031-03

93032-03

93086-03

93087-03

93880

93870

93550

25106

See table of adapters, according to the size of the cover.
(See pages 126-127).

51624-03

See next page

Adapters for Trunking 93 cover 65 mm.

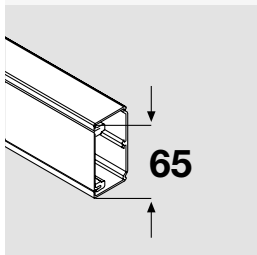

50x80	50x150	70x170
93020-03	93074-03	93086-03

See next page for mounting of switches and sockets in trunkings with cover 80 mm.

Single plate RJ45

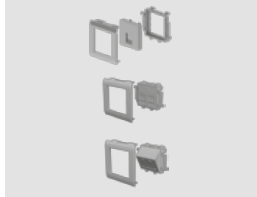

Flat 1RJ45	93749-03 (1)
Flat 2RJ45	93751-03 (1)
Angled 2RJ45	93753-03 (2)

Single adapter

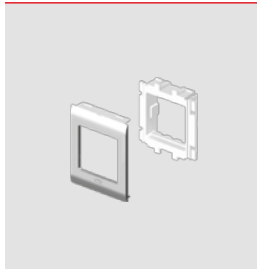

Niessen Zenit*	93635-03
BJC* Sol	93661-03
Simon* 27	93623-03
Simon Connect* K45	93608-03 (3)
Mosaic* and compatible	93608-03
Eunea Unica*	93653-03

Double adapter

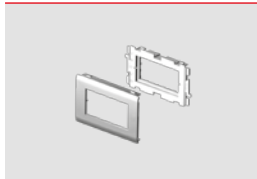

Simon Connect* K45	93613-03 (3)
Mosaic* and compatible	93613-03
Eunea Unica*	93656-03
Simon CIMA 500*	93640-03

Triple adapter



Simon Connect* K45	93618-03 (3)
Mosaic* and compatible	93618-03

Adapter DIN



93648-03

Socket boxes (5)



Single adapter	Double adapter	Triple adapter
93713	93718	93728

- (1) Compatible with RJ45 Systimax solutions and Universal type Keystone (AMP, Krone, Nexans, Jetlan, Belden, Brand-Rex and OPENETICS). For specific types or brands, please contact us.
- (2) Compatible with RJ45 Universal type Keystone (AMP, Krone, Nexans, Jetlan, Belden, Brand-Rex and OPENETICS). For specific types or brands, please contact us.
- (3) Most of the switches and sockets of K type are compatible with this adapter. However, there are some part numbers (for example KB076, KB76, K130A, 2u. KA76, 2u. K302 + K115, etc.) that can only be mounted on the double plate 93613-03 or on the triple plate 93618-03 in the central area, placing blind lids on the sides.
- (4) For electrical outlets DIN, the box 93718 is necessary to separate circuits.
- (5) The use of the box is necessary to assure the separation of circuits.

*These brands belong to third parties, they are not related to Unex aparellaje eléctrico, S.L.

See next page

Adapters for Trunking 93 cover 80 mm.

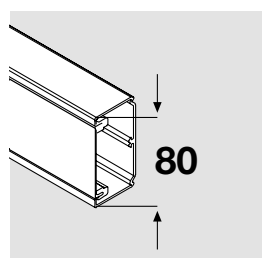

50x100	70x100	70x130	70x170	70x210
93021-03	93031-03	93032-03	93086-03	93087-03



See last page for mounting of switches and sockets in trunkings with cover 65 mm.

Universal single adapter (1)

	Universal CEE-7	93604
	Universal outlet box	93709

Single industrial outlet box (2)

		93708
--	--	--------------

Single plate RJ45

	Flat 1RJ45	93750-03 (3)
	Flat 2RJ45	93752-03 (3)
	Angled 2RJ45	93754-03 (4)

Single adapter

	Niessen Zenit*	93636-03
	BJC* Sol	93662-03
	Simon* 27	93624-03
	Simon Connect* K45	93609-03 (5)
	Mosaic* and compatible	93609-03
	Eunea Unica*	93654-03

Double adapter |

	Simon CIMA 500*	93641-03
	Simon Connect* K45	93614-03 (5)
	Mosaic* and compatible	93614-03
	Eunea Unica*	93657-03
	Universal	93644-03 (6)

Triple adapter | |

	Simon Connect* K45	93619-03 (5)
	Mosaic* and compatible	93619-03

Adapter DIN (7)

		93649-03
--	--	-----------------

Socket boxes (8)

	Single adapter	Double adapter	Triple adapter
	93714	93719 (9)	93729 (9)

(1) Frames shall be supplied by the socket manufacturer. We recommend frames with straight corners.

(2) Box for industrial outlets, compatible with some outlets from Mennekes brand and others. Please contact us for details.

(3) Compatible with RJ45 Systimax solutions and Universal type Keystone (AMP, Krone, Nexans, Jetlan, Belden, Brand-Rex and OPENETICS). For specific types or brands, please contact us.

(4) Compatible with RJ45 Universal type Keystone (AMP, Krone, Nexans, Jetlan, Belden, Brand-Rex and OPENETICS). For specific types or brands, please contact us.

(5) Most of the switches and sockets of K type are compatible with this adapter. However, there are some part numbers (for example KB076, KB76, K130A, 2u. KA76, 2u. K302 + K115, etc.) that can only be mounted on the double plate 93614-03 or on the triple plate 93619-03 in the central area, placing blind lids on the sides.

(6) 1, 2 or 3 outlets of 25 mm. module can be installed.

(7) For electrical outlets DIN, the box 93719 is necessary to separate circuits or to fix in trunkings of 70 mm high.

(8) The use of the box is necessary to assure the separation of circuits.

(9) Contains a divider part no. 93720 to separate circuits. It can also be sold individually.

*These brands belong to third parties, without relationship with Unex aparellaje eléctrico, S.L.

Useful cross-sections (mm²)

		Sizes (mm)			
		50x80	50x100	50x150	
Part no.	Aluminium RAL 9006	93020-03	93021-03	93074-03	
Mounting of switches and socket outlets					
Universal outlets without box			2150		
Modular outlets without box		1565	2140	1425 1425	
Universal or industrial outlets with box			675 675		
Modular and DIN outlets with box		440 440	480 480	425 320 320 425	
Distribution					
Without divider		3110	3890	2955 2955	
With divider		1400 1400	1795 1795	1380 1275 1275 1380	
With divider and corner-piece		1075 1075	1385 1385	1070 985 985 1070	

70x100

70x130

70x170

70x210

93031-03

93032-03

93086-03

93087-03

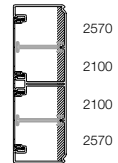
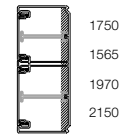
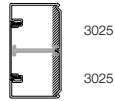
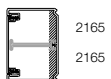
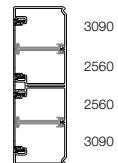
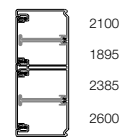
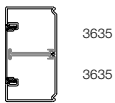
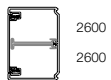
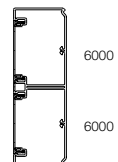
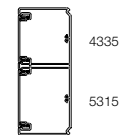
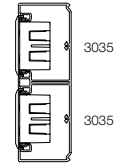
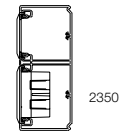
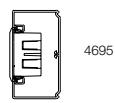
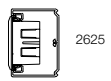
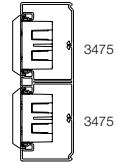
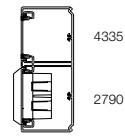
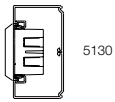
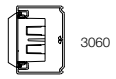
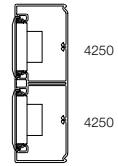
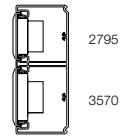
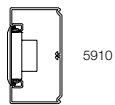
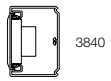
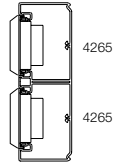
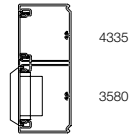
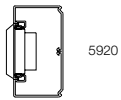
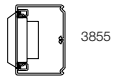

www.unex.net

Technical information

- Technical specifications
- Mounting instructions
- Different database formats



YouTube Unex Solutions

- Mounting videos

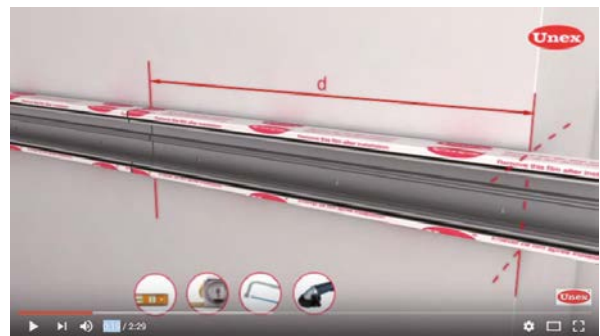

COPYRIGHT: All trademarks, brands or distinctive signs, of any kind, that might appear in the present website are the property of Unex aparellaje eléctrico, S.L. or of third parties. The use or access to the present website and/or to its services should not be interpreted, under no circumstances, as conferring any rights to the User on the mentioned trademarks, brands or distinctive signs.

Furthermore, all Contents are the property of Unex aparellaje eléctrico, S.L. or of third parties. As stated in the mentioned Legal Notice, none of the operation rights existing or that might exist about the mentioned Contents should be understood as transferable to the User, beyond those strictly necessary for the correct use of the Portal and the Services.

