



Power supply
system for
work spaces

Trunking 93

raw material
colour

U23X

White

For perimeter power supply of work spaces

- **Free choice of switches and sockets.**
- Possibility to **attach or flush-mount** the trunking on walls and furniture.
- Fix compartments with independent covers.
- Internal lid.
- Possibility of double and triple covers, resulting in independent compartments (power, data, etc.).
- **Can be painted.**

Raw material





Trunking

Fittings, accessories and switches and sockets adapters

Compliant

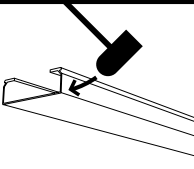
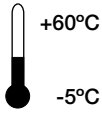
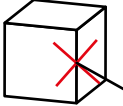

Technical characteristics

Electrical	Mechanical	Temperature	Protection degree	In front of fire
				
EN 50085-2-1*	EN 50085-2-1*	EN 50085-2-1*	EN 50085-2-1*	
<p>Insulating material.</p> <hr/> <p>No earthing required.</p>	<p>IK08 type 3 (distribution and mounting of switches and sockets).</p> <hr/> <p>7 trunking sizes certified IK10 Type 1.</p>		<p>IP4X, mounted on the wall.</p>	<p>Glow-wire test 960°C.</p> <hr/> <p>Non flame propagating.</p> <hr/> <p>Reaction to fire, Class M1 acc./UNE 201010.</p> <hr/> <p>Flammability degree UL94: V0. Does not spread fire by dripping.</p>

* BS EN 50085-2-1 is the UK implementation of EN 50085-2-1.



Length

2 m

Colour

White**RAL 9010**

Quality marks



Approvals



Bureau Veritas



Φ3 от 22.07.08 N 123-Φ3
ГОСТ P 53313-2009

Conformity declaration



See updated technical
information of each
part number on
www.unex.net



School



Health care



Health care



Work spaces: office



Work spaces: office



Work spaces: office



School

Use

Trunking as continuous box

Trunking allows to set the work spaces in any position to facilitate the extension and modification depending on the user's needs.



Integration of different types of installations in the same trunking.



Large capacity for cables

11 sizes of Trunking 93 available with 1, 2 and 3 covers, meet all the needs of cable management and power supply of outlets through the wall.

1 cover trunking

- The removable divider is easy to mount and has a solid fixing to the base in order to separate power and data.
- In case of circuit separation, a socket box is required.



2 covers trunking

- Independent compartments with fixed divider.
- Independent access for the users to any type of installation.
- The spare section for the passing of cables increases, because it is not necessary to use switches and sockets boxes.



3 covers trunking

- Independent compartments with fixed divider.
- Central compartment for switches and sockets: facilitates the cabling path when there are many consecutive work spaces.
- Divider protective piece: allows you to keep the right bending radius in the passage across dividers.



Mounting options

On the wall or flush-mounted

Unex trunkings are designed for their mounting on the wall or flush-mounted on brick walls or plaster board, partitions, wooden linings, etc.



Skirting board



Windowsill



Embedded

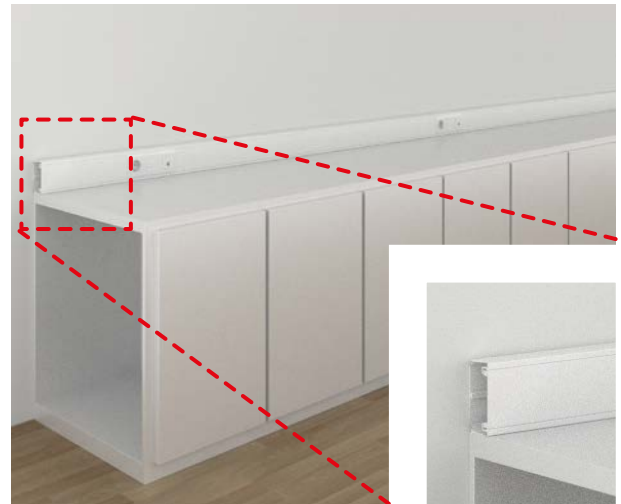

Attached to the furniture

Aesthetically integrated

Unex trunkings can be painted to blend neatly into just any kind of environment.



Safe and easy installation

Trunking and fittings

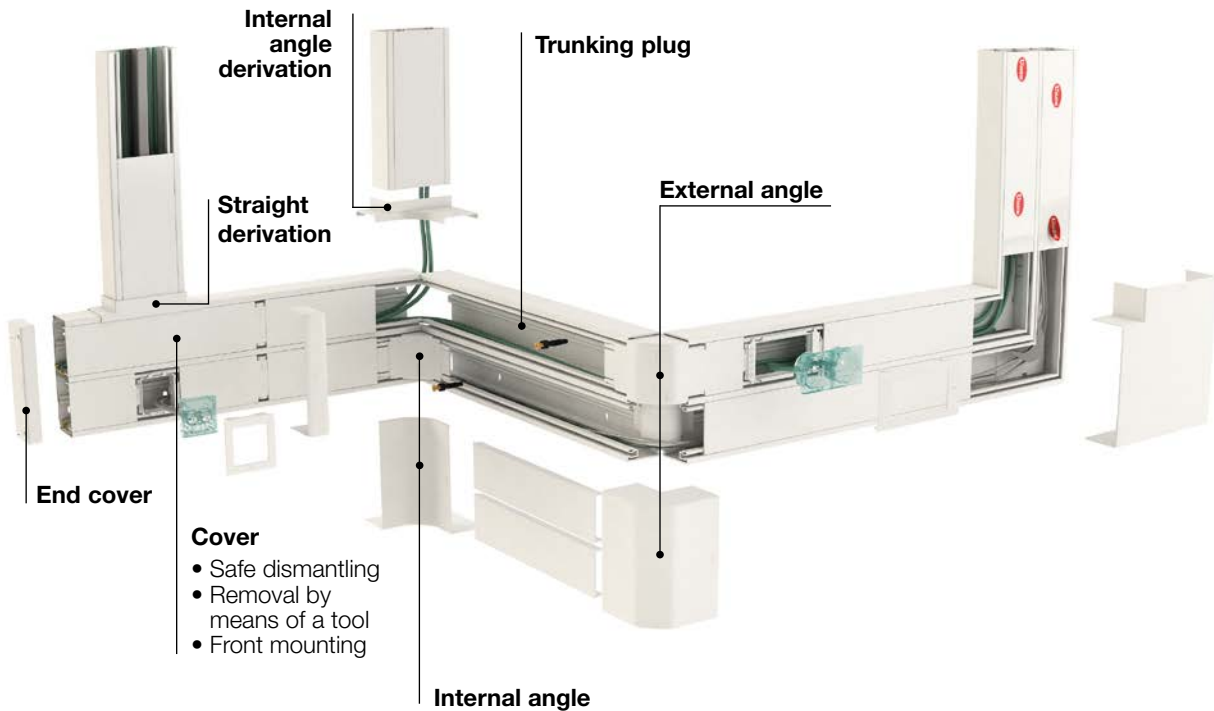

YouTube Unex Solutions

Protective film



For all trunking part numbers.

Fittings in 2 pieces

Internal angle



External angle

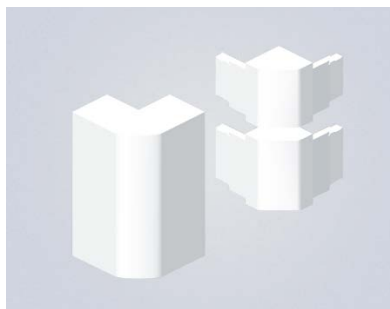

- The **internal piece** allows easy measuring of the cover and holds the cables.
- The **external piece** covers the cut marks of base and cover. It is not necessary to slide the cover. Assures protection degree IP4X.

Mounting of switches and sockets

Safe and easy installation

Double-piece adapters:

- **Internal piece:** for a solid fixing to the base and easy measuring of the cover.
- **External and embellishing pieces:** hide the cover cut marks.
- Protection against solid foreign objects IP4X.



Flexibility to combine a variety of switches and sockets

Unex trunkings are designed to combine different types of installations: electrical, TV, audio-video, sound, data, security, control, etc.

Possibility of extension and evolution of the installations with no dependence on the type of outlet installed.



Flexibility to combine a variety of switches and sockets

Electrical outlets

Universal CEE-7



- Niessen* Olas, Arco, Tacto, Zenit and Stylo.
- BJC*.
- Jung*.
- Simon* 31, 75, 88, 82.
- Mosaic*.
- Valena*.
- Bticino*.
- Eunea*.
- Berker*.
- Gewiss*.

Industrial socket box



- Mennekes*.
- ABL*.
- Simon*.

Modular



- Niessen Zenit*.
- Simon* 27.
- Simon Connect* K45 (and compatible).
- Mosaic*.
- Eunea Unica*.
- BJC Sol*.

Modular double



- Mosaic*.
- Simon Connect* K45 "linkable".
- Eunea Unica*.
- Simon CIMA 500*.

Modular triple



- Simon Connect* K45 "linkable".
- Mosaic*.

Universal



- Niessen* Zenit.
- Bticino*.
- Unica-Allegro* (3 modules).
- Gewiss*.

DIN (Bipolar)



- MCB's (Miniature circuit breakers).
- RCD's (Residual current devices).

Data connectors

Flat plate 1 RJ45



- Compatible with:
- Systemax solutions.
 - Universal type Keystone.

Flat plate 2 RJ45



- Compatible with:
- Systemax solutions.
 - Universal type Keystone.

Angled plate 2 RJ45



- Compatible with:
- Universal type Keystone.

* These brands belong to third parties; they are not related to Unex aparellaje eléctrico, S.L.

Safety

Electrical safety

Protection degree IP4X against solid foreign objects:

The system of adapters for Trunking 93 assures protection degree IP4X or IPXXD against solid foreign objects, acc./EN 50085-2-1.



Resistance to wrenching:

The adapters for power outlets resist 81N, in compliance with EN 50085-1 and European regulations of power outlets.

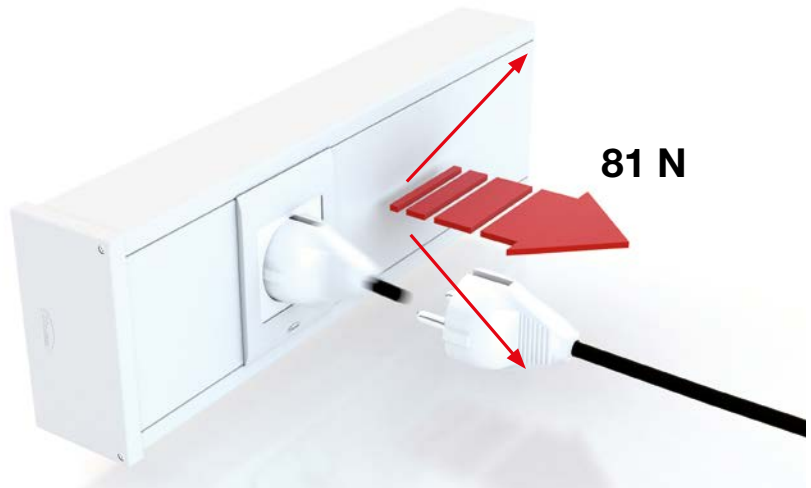

Mechanical safety:

To meet the most demanding impact requirements, NF has certified 7 sizes of Trunking 93 as IK10 Type 1 and 4 sizes as IK09 Type 1:

Part number*	Type I	Size
93020-2	IK10	50x80
93021-2	IK10	50x100
93022-2	IK10	50x130
93031-2	IK10	70x100
93032-2	IK10	70x130
93074-2	IK09	50x150
93076-2	IK09	50x170
93086-2	IK10	70x170
93087-2	IK09	70x210
93125-2	IK09	50x170
93138-2	IK10	70x230

* product marking in process, see www.unex.net



Safer installations

Trunking 70 mm, bigger bending radius:

- Allows the necessary bending radius for passing the data cables acc./EN 50174-2.
- Larger spare section for cable passing.



Protection of IT cables:





- Data cabling can keep the right bending radius according to EN 50174-2.

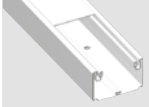

Circuit separation:

- Unex 2 lid cover trunking allows to separate cabling and outlets, making unnecessary the use of a socket box for this purpose.



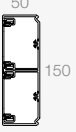







		Trunking sizes (mm)			
		50x80	50x100	50x130	50x150
	White RAL 9010 (Part no. 93xxx-2)				
Cover sizes (mm)		65	80	80	65 65
Maximum number of compartments		2	2	2	4
Trunking 2 m		93020-2	93021-2	93022-2	93074-2

Accessories in **U23X**

	Divider 2 m	93820
---	-----------------------	--------------

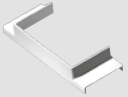
Fittings in **U24X**





	Flat angle	93220-2	93221-2	93222-2	93224-2
	External angle	93270-2	93271-2	93272-2	93274-2
	Outer variable angle	73309-2			
	Internal angle	93320-2	93321-2	93322-2	93324-2
	Inner variable angle	73359-2			
	End cover	93370-2	93371-2	93372-2	93374-2
	Joint cover piece	93520-2	93521-2	93522-2	93524-2
	Straight derivation Branching to a 100 mm wide trunking	93421-2			
	Internal angle derivation Branching to a 100 mm wide trunking	93471-2			
	L Profile 2 m	93575-2			



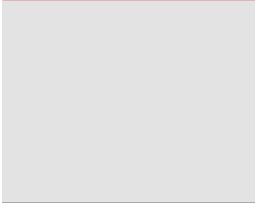

50x170		50x170			70x100	70x130	70x170		70x210		70x230		
65	80	37	65	37	80	80	65	80	80	80	65	65	65
4		4			2	2	4		4		6		
93076-2		93125-2			93031-2	93032-2	93086-2		93087-2		93138-2		

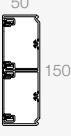
93820					93830				
-------	--	--	--	--	-------	--	--	--	--



93226-2	93225-2	93231-2	93232-2	93236-2	93237-2	93238-2
93276-2	93275-2	93281-2	93282-2	93286-2	93287-2	93288-2
73309-2						
93326-2	93325-2	93331-2	93332-2	93336-2	93337-2	93338-2
73359-2						
93376-2	93376-2	93381-2	93382-2	93386-2	93387-2	93388-2
93526-2	93525-2	93531-2	93532-2	93536-2	93537-2	93538-2
93421-2		93431-2				
93471-2		93481-2				
93575-2						

		Trunking sizes (mm)			
		50x80	50x100	50x130	50x150
	White RAL 9010 (Part no. 93xxx-2)				
Cover sizes (mm)		65	80	80	65 65
Maximum number of compartments		2	2	2	4
	Trunking 2 m	93020-2	93021-2	93022-2	93074-2

Fittings in **U23X** and in **U24X**

	Floor strip 2 m U23X	93570-2			
	Floor strip external angle	93572-2			

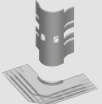
Cable protection elements in **U24X**

	Corner-piece flat angle	93880			
	Corner-piece external angle	93870			
	Divider protective piece				93862

Other accessories in **U23X**

	Junction	93550			
---	----------	-------	--	--	--

Fixing elements in **U63X**

	Trunking plug Note: Use drill bit Ø6 mm.	25106			
---	---	-------	--	--	--

Adapters for switches and sockets in **U24X**

	Adapter for switches and sockets	See table of adapters, according to the size of the cover. (See pages 104-105).			
---	----------------------------------	--	--	--	--

Modular adaptation of the Flexible runway 51 in **U24X** (See Furniture supply 51)

	Modular adapter for Flexible runway 51	51623-2	51624-2	51623-2	
---	--	---------	---------	---------	--



50x170		50x170			70x100	70x130	70x170		70x210		70x230		
65	80	37	65	37	80	80	65	80	80	80	65	65	65
4		4			2	2	4		4		6		
93076-2		93125-2			93031-2	93032-2	93086-2		93087-2		93138-2		

93570-2		93580-2		
93572-2		93582-2		

93880			
93870			
	93862		

93550			
-------	--	--	--

25106			
-------	--	--	--

See table of adapters, according to the size of the cover.
(See pages 104-105).

51623-2	51624-2	51623-2	51624-2	51623-2	51624-2	51623-2
---------	---------	---------	---------	---------	---------	---------

See next page

Adapters for Trunking 93 cover 65 mm.

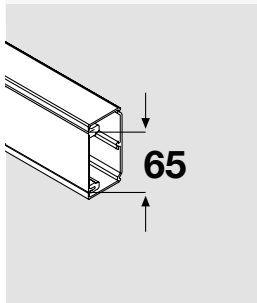

50x80	50x150	50x170	50x170	70x170	70x230
93020-2	93074-2	93076-2	93125-2	93086-2	93138-2

⊘ See next page for mounting of switches and sockets in trunkings with cover 80 mm.
 ✗ Not suitable for trunkings with 37 mm cover.

Single plate RJ45

	Flat 1RJ45	93749-2 (1)
	Flat 2RJ45	93751-2 (1)
	Angled 2RJ45	93753-2 (2)

Single adapter

	Niessen Zenit*	93635-2
	BJC* Sol	93661-2
	Simon* 27	93623-2
	Simon Connect* K45	93608-2 (3)
	Mosaic* and compatible	93608-2
	Eunea Unica*	93653-2

Double adapter

	Simon Connect* K45	93613-2 (3)
	Mosaic* and compatible	93613-2
	Eunea Unica*	93656-2
	Simon CIMA 500*	93640-2

Triple adapter

	Simon Connect* K45	93618-2 (3)
	Mosaic* and compatible	93618-2

Adapter DIN

		93648-2
--	--	----------------

Socket boxes (5)

	Single adapter	Double adapter	Triple adapter
	93713	93718	93728

(1) Compatible with RJ45 Systimax solutions and Universal type Keystone (AMP, Krone, Nexans, Jetlan, Belden, Brand-Rex and OPENETICS). For specific types or brands, please contact us.
 (2) Compatible with RJ45 Universal type Keystone (AMP, Krone, Nexans, Jetlan, Belden, Brand-Rex and OPENETICS). For specific types or brands, please contact us.
 (3) Most of the switches and sockets of K type are compatible with this adapter. However, there are some part numbers (for example KB076, KB76, K130A, 2u. KA76, 2u. K302 + K115, etc.) that can only be mounted on the double plate 93613-2 or on the triple plate 93618-2 in the central area, placing blind lids on the sides.
 (4) For electrical outlets DIN, the box 93718 is necessary to separate circuits or to fix in trunkings of 70 mm high.
 (5) The use of the box is necessary to assure the separation of circuits.
 *These brands belong to third parties; they are not related to Unex aparellaje eléctrico, S.L.

See next page

Adapters for Trunking 93 cover 80 mm.

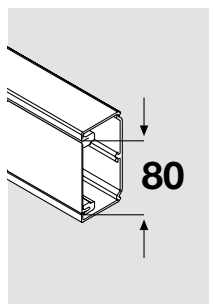

50x100	50x130	50x170	70x100	70x130	70x170	70x210
93021-2	93022-2	93076-2	93031-2	93032-2	93086-2	93087-2

See last page for mounting of switches and sockets in trunkings with cover 65 mm.



Universal single adapter (1)

	Universal CEE-7	93604
	Universal outlet box	93709

Single industrial outlet box (2)

		93708
--	--	--------------

Single plate RJ45 (3)

	Flat 1RJ45	93750-2 (3)
	Flat 2RJ45	93752-2 (3)
	Angled 2RJ45	93754-2 (4)

Single adapter (4)

	Niessen Zenit*	93636-2
	BJC* Sol	93662-2
	Simon* 27	93624-2
	Simon Connect* K45	93609-2 (5)
	Mosaic* and compatible	93609-2
	Eunea Unica*	93654-2

Double adapter (5)

	Simon CIMA 500*	93641-2
	Simon Connect* K45	93614-2 (5)
	Mosaic* and compatible	93614-2
	Eunea Unica*	93657-2
	Universal	93644-2 (6)

Triple adapter (6)

	Simon Connect* K45	93619-2 (5)
	Mosaic* and compatible	93619-2

Adapter DIN (7)

		93649-2
--	--	----------------

Socket boxes (8)

	Single adapter	Double adapter	Triple adapter
	93714	93719 (9)	93729 (9)

(1) Frames shall be supplied by the socket manufacturer. We recommend frames with straight corners.

(2) Box for industrial outlets, compatible with some outlets from Mennekes brand and others. Please contact us for details.

(3) Compatible with RJ45 Systimax solutions and Universal type Keystone (AMP, Krone, Nexans, Jetlan, Belden, Brand-Rex and OPENETICS). For specific types or brands, please contact us.

(4) Compatible with RJ45 Universal type Keystone (AMP, Krone, Nexans, Jetlan, Belden, Brand-Rex and OPENETICS). For specific types or brands, please contact us.

(5) Most of the switches and sockets of K type are compatible with this adapter. However, there are some part numbers (for example KB076, KB76, K130A, 2u. KA76, 2u. K302 + K115, etc.) that can only be mounted on the double plate 93614-2 or on the triple plate 93619-2 in the central area, placing blind lids on the sides.

(6) 1, 2 or 3 outlets of 25 mm. module can be installed.

(7) For electrical outlets DIN, the box 93719 is necessary to separate circuits or to fix in trunkings of 70 mm high.

(8) The use of the box is necessary to assure the separation of circuits.

(9) Contains a divider part no. 93720 to separate circuits. It can also be sold individually.

*These brands belong to third parties; they are not related to Unex aparellaje eléctrico, S.L.

Useful cross-sections (mm²)

Part no.	White RAL 9010	Sizes (mm)			
		50x80	50x100	50x130	50x150
		93020-2	93021-2	93022-2	93074-2

Mounting of switches and socket outlets

Universal outlets without box			2150	3680	
Modular outlets without box		1565	2140	3670	1425 1425
Universal or industrial outlets with box			675 675	1435 1435	
Modular and DIN outlets with box		440 440	480 480	1245 1245	425 320 320 425

Distribution

Without divider		3110	3890	5415	2955 2955
With divider		1400 1400	1795 1795	2555 2555	1380 1275 1275 1380
With divider and corner-piece		1075 1075	1385 1385	1985 1985	1070 985 985 1070

50x170

50x170

70x100

70x130

70x170

70x210

70x230

93076-2

93125-2

93031-2

93032-2

93086-2

93087-2

93138-2

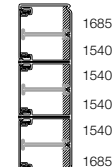
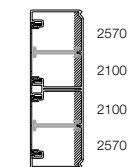
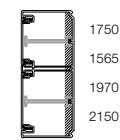
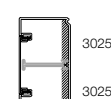
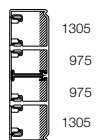
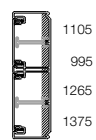
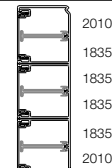
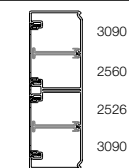
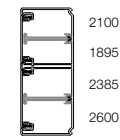
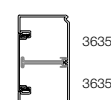
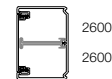
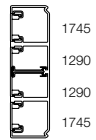
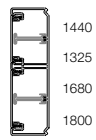
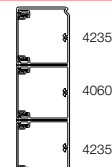
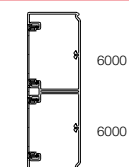
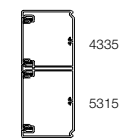
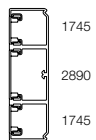
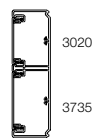
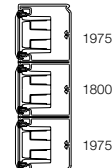
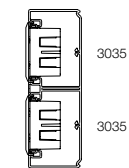
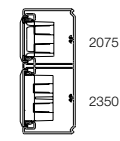
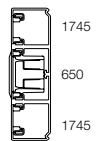
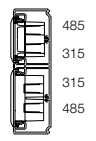
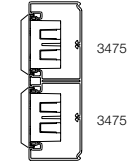
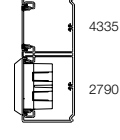
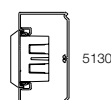
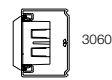
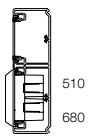
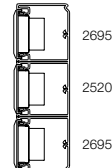
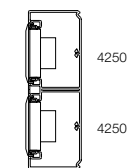
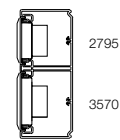
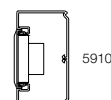
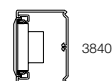
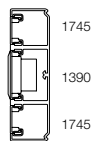
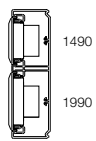
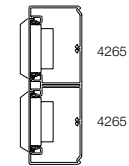
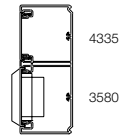
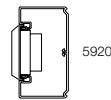
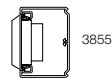
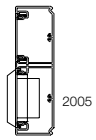

Technical information

- Technical specifications
- Mounting instructions
- Different database formats



YouTube Unex Solutions

- Mounting videos

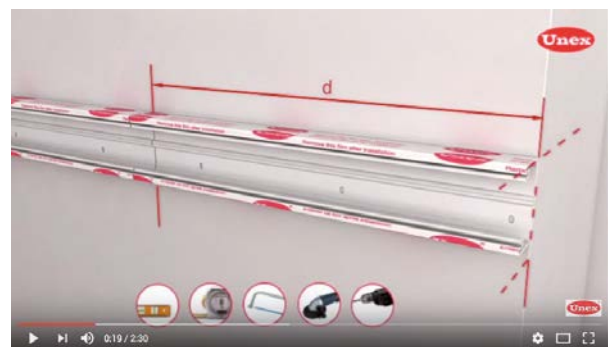

COPYRIGHT: All trademarks, brands or distinctive signs, of any kind, that might appear in the present website are the property of Unex aparellaje eléctrico, S.L. or of third parties. The use or access to the present website and/or to its services should not be interpreted, under no circumstances, as conferring any rights to the User on the mentioned trademarks, brands or distinctive signs.

Furthermore, all Contents are the property of Unex aparellaje eléctrico, S.L. or of third parties. As stated in the mentioned Legal Notice, none of the operation rights existing or that might exist about the mentioned Contents should be understood as transferable to the User, beyond those strictly necessary for the correct use of the Portal and the Services.

