



Sistema di
distribuzione in
quadri e cabine

Canali per cablaggio senza alogeni

88

materia prima

U43X

colore

Grigio

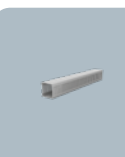

Per la conduzione di cavi in quadri e cabine

- **La robustezza del canale apporta una maggiore sicurezza all'impianto.**
- Facile montaggio e smontaggio del coperchio, con grande sicurezza di chiusura.
- Possibilità di fissaggio in sospensione a soffitto.
- Possibilità di derivare fino alla base del canale.
- Assenza di sbavature e punte taglienti: non danneggia né l'utente né il cavo.
- **Materiale isolante senza alogeni.**

Materia prima



U43X

Canali, collari
e ponte pattatore

Conforme

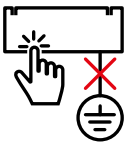

Caratteristiche tecniche

Elettrica	Temperatura	Fuoco
		
<p>EN 50085-2-3</p> <ul style="list-style-type: none"> • Con proprietà elettriche isolanti. • Non richiede messa a terra. 	<p>EN 50085-2-3</p> <ul style="list-style-type: none"> • Temperatura minima di immagazzinamento e di trasporto: -45°C. • Temperatura massima d'uso: +90°C. <p>Questa norma non comprende prove a lungo termine.</p> <hr/> <p>UL 1565</p> <ul style="list-style-type: none"> • Temperature rating: +80°C. <p>Questa norma prende in considerazione prove a lungo termine.</p>	<p>EN 50085-2-3</p> <ul style="list-style-type: none"> • Test del filo incandescente a 960°C. • Non propagatore della fiamma. <hr/> <p>UL94</p> <ul style="list-style-type: none"> • Grado infiammabilità: V0. • Non trasmette il fuoco per gocciolamento. <hr/> <p>EN 45545-2</p> <ul style="list-style-type: none"> • Reazione al fuoco in materiale rotabile ferroviario: HL3-R22.

Segui le istruzioni di pag. 15 per consultare e scaricare la **scheda tecnica** del prodotto dalla nostra pagina web www.unex.net

Canali
senza alogeni

88 **U43X**
Grigio

HL3-R22
S/EN 45545-2

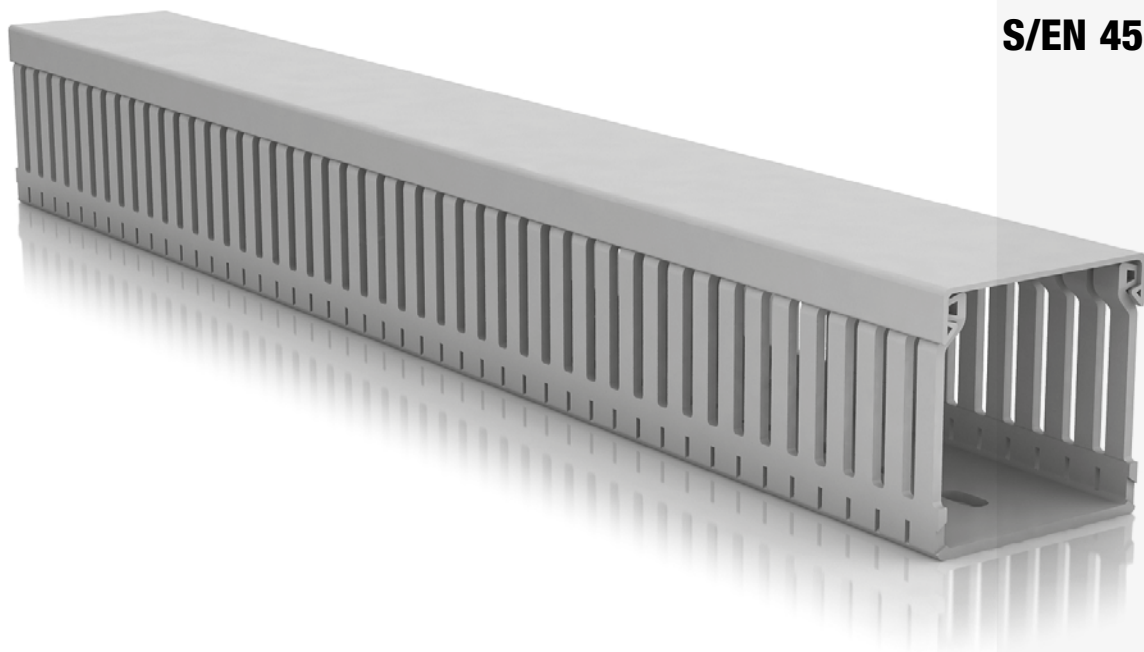

Lunghezza

2 m

Colore

Grigio

RAL 7035

Marchi di qualità



EN 50085-2-3:2010



EN 50085-2-3:2010



EN 50085-2-3:2010



File number E 75725 (M).



ГОСТ P
50827:2009

Omologazioni



Germanischer Lloyd



Bureau Veritas



Canadian Standards Association



Iberdrola NI 76.83.01



Φ3 от 22.07.08 N 123-Φ3
ГОСТ P 53313-2009

Dichiarazioni di conformità





Materiale rotante



Aeroporti



Segnalamento ferroviario



Aeroporti



Produzione e distribuzione di energia elettrica

88

U43X

Grigio

Canali
senza alogeni

Comodità di montaggio e manutenzione

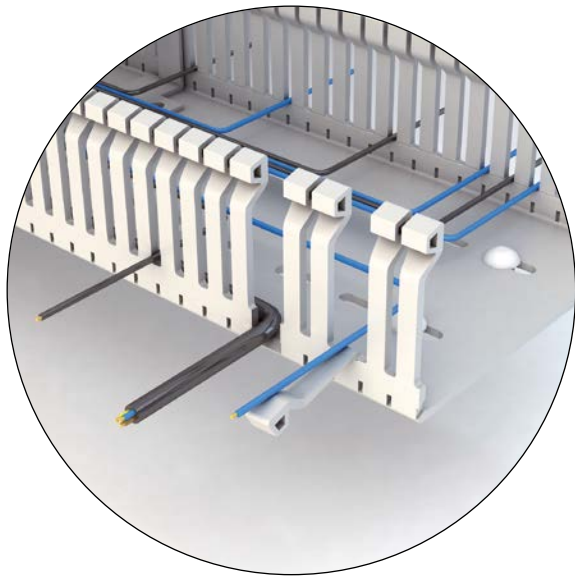

Linguette flessibili e resistenti: non si rompono accidentalmente.

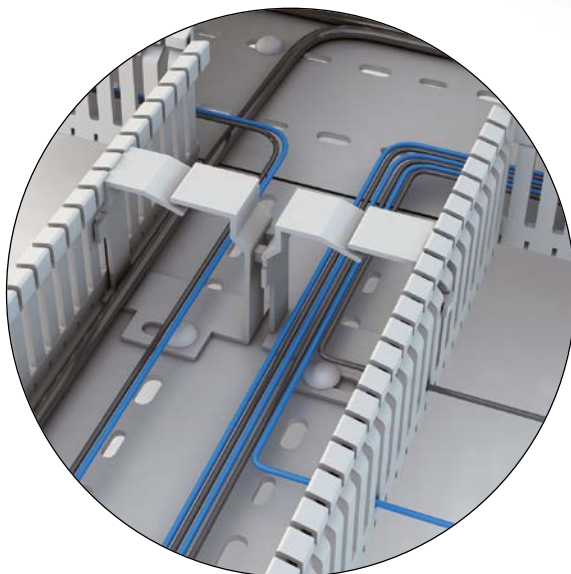
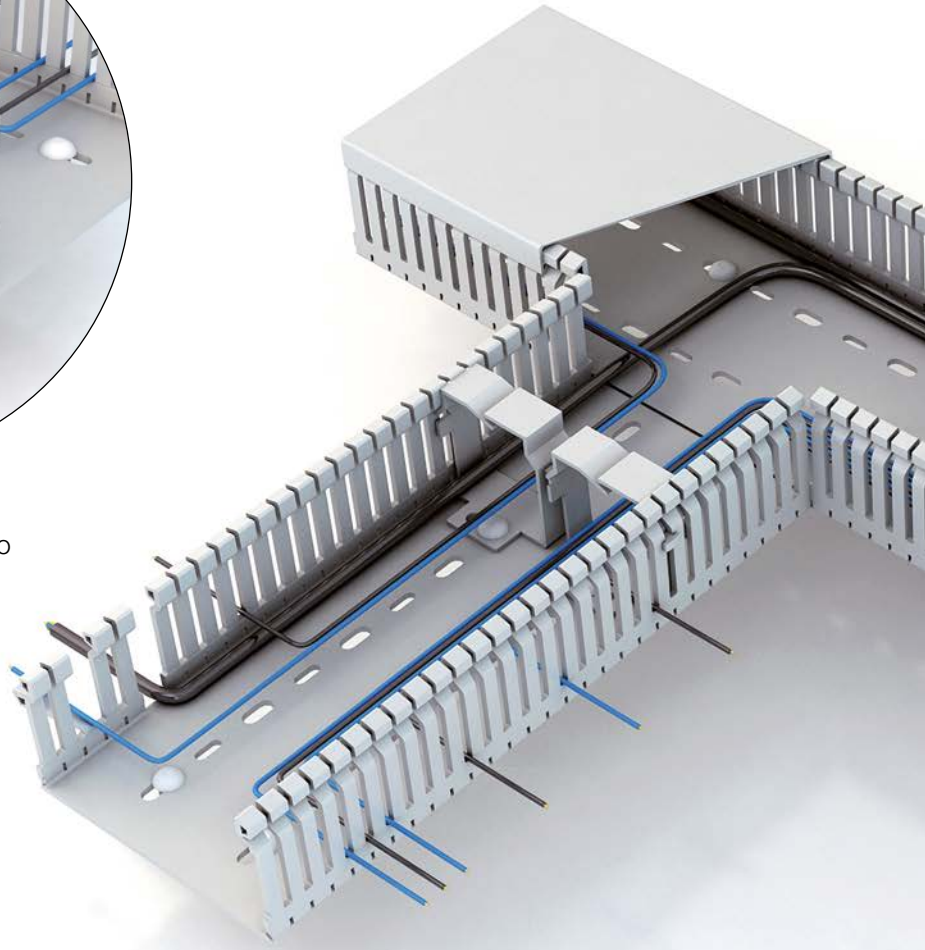

Collari: facilitano la separazione dei circuiti. Solo 6 articoli per 12 dimensioni di canali.

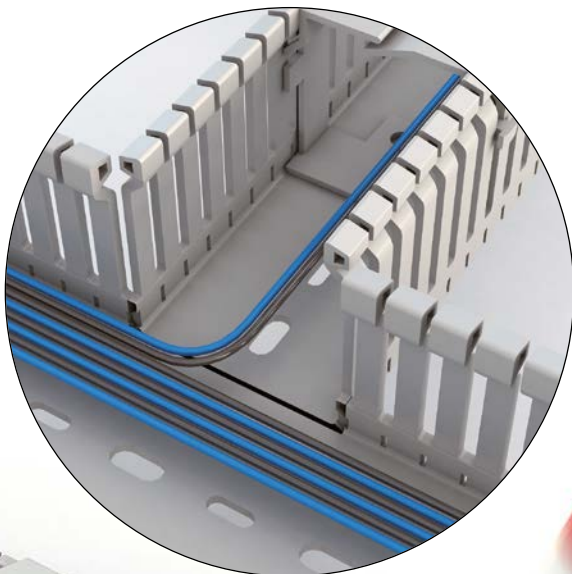

Taglio netto fino alla base per realizzare derivazioni laterali. Ottimizzazione dello spazio in derivazioni. Non si danneggia l'isolamento del cavo.

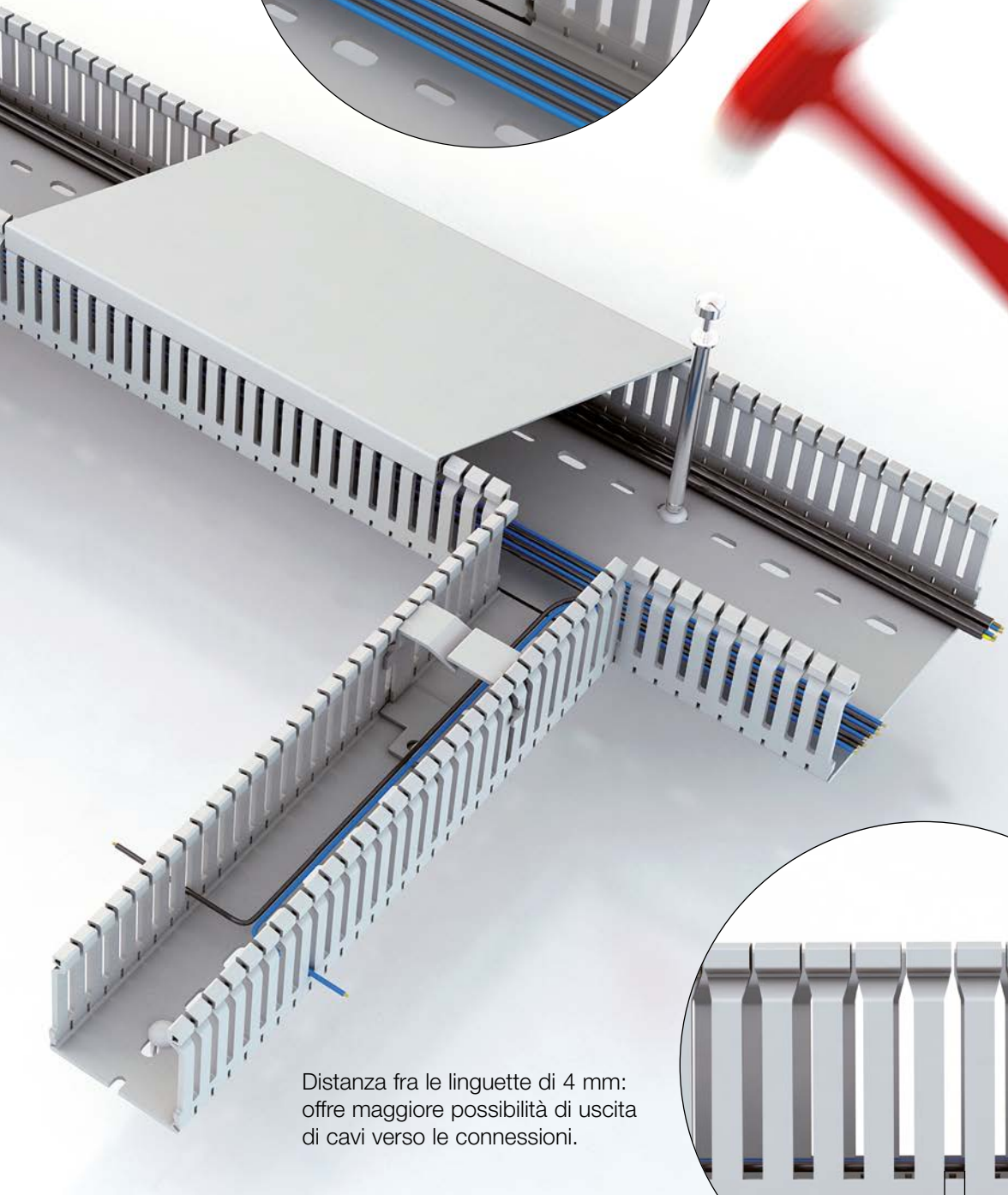

Distanza fra le linguette di 4 mm: offre maggiore possibilità di uscita di cavi verso le connessioni.

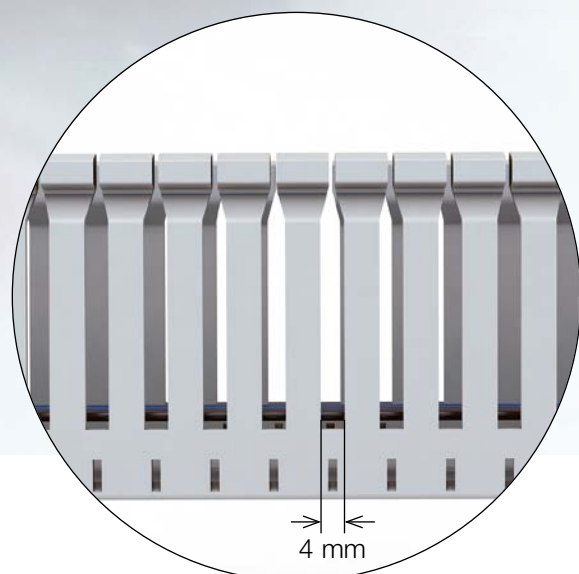

Prodotto con valore aggiunto

Canali senza sbavature

Linea pulita, senza spigoli né punte taglienti. Non provocano graffi all'installatore.
Non danneggia l'isolamento dei cavi durante il montaggio, il trasporto né in applicazioni soggette a vibrazioni.

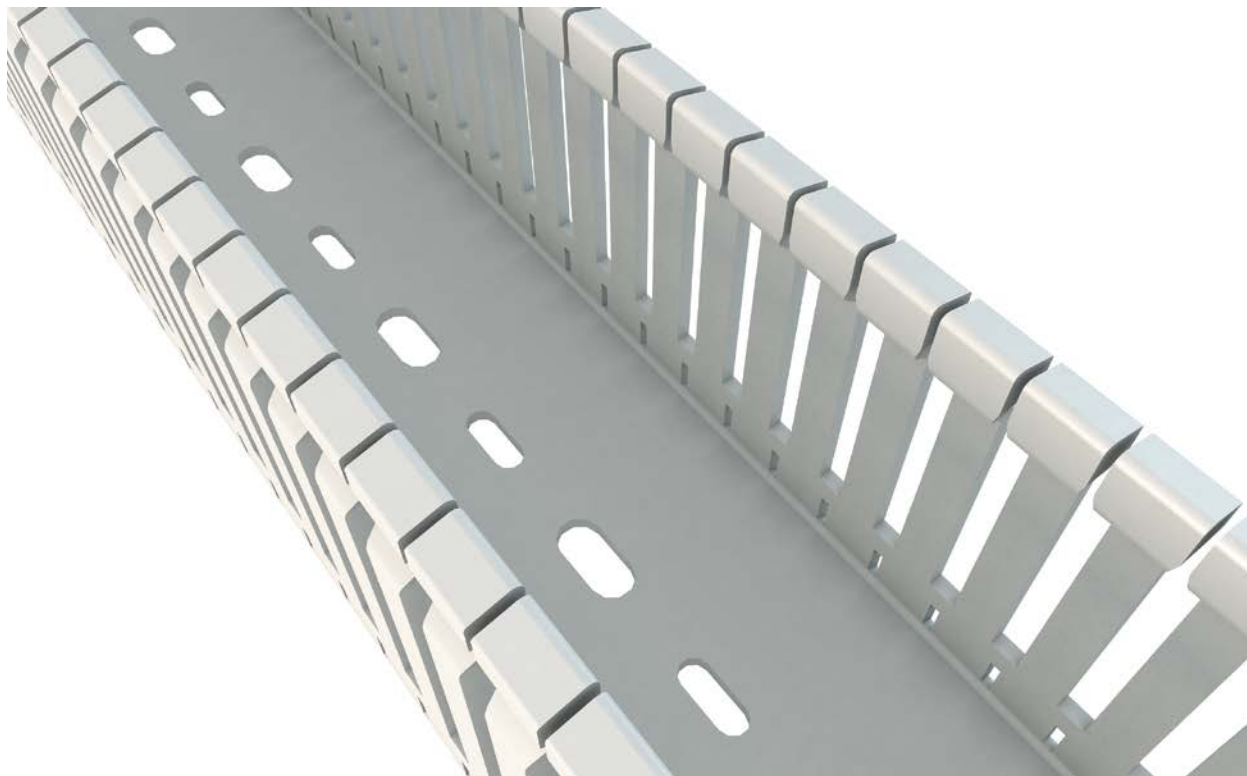

Coperchio

Facile montaggio e smontaggio del coperchio.



In posizione orizzontale le linguette non si deformano ed il coperchio non cade.

In posizione verticale il coperchio non scivola verso il basso.

Canali stabili e robusti

Grazie alla sua robustezza e solidità, il canale può essere sospeso fra due profili. Occorrerà usare fissaggi per sostenerlo ai profili.



Ponte compattatore

Un unico articolo per tutte le dimensioni del canale: si taglia a seconda della larghezza del canale. Regolabile in altezza.



Possibilità di verniciatura

I canali da cablaggio Unex si possono verniciare.

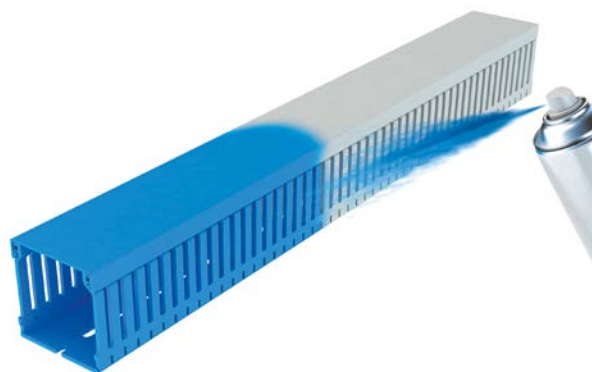



88

U43X

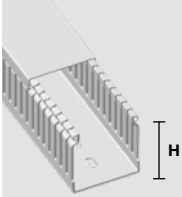

Grigio

Canali
senza alogeni



Altezze 25, 30 e 40 mm

		Larghezza dei canali (mm)		
		20	30	40
		Grigio RAL 7035		
	H = 25 mm	25.20.88 60 m		
	H = 30 mm		30.30.88 60 m	
	H = 40 mm	40.20.88 72 m	40.30.88 48 m	40.40.88 32 m
	Ponte compattatore		40850 48 pz.	



Altezze 60 mm

		Larghezza dei canali (mm)		
		20	30	40
	Canale 2 m H = 60 mm		60.30.88 36 m	60.40.88 32 m
	Collare			40864-4 24 pz.
	Ponte compattatore		40850 48 pz.	

Altezze 80 mm

		Larghezza dei canali (mm)		
		20	30	40
	Canale 2 m H = 80 mm		80.30.88 28 m	80.40.88 24 m
	Collare			40884-4 24 pz.
	Ponte compattatore		40850 48 pz.	

Altezze 100 mm

		Larghezza dei canali (mm)		
		20	30	40
	Canale 2 m H = 100 mm			100.40.88 16 m
	Collare			40894-4 24 pz.
	Ponte compattatore			40850 48 pz.



60	80	100	120
40.60.88			
24 m			
40850			
48 pz.			

60	80	100	120
60.60.88			
32 m			
40865-4			
24 pz.			
40850			
48 pz.			
		60.120.88	
		12 m	
		40865-4	
		24 pz.	
		40865-4	
		24 pz.	
		40850	
		48 pz.	

60	80	100	120
80.60.88			
24 m			
40885-4			
24 pz.			
80.80.88			
24 m			
40884-4			
24 pz.			
40884-4			
24 pz.			
80.100.88			
12 m			
40884-4			
24 pz.			
40885-4			
24 pz.			
80.120.88			
12 m			
40885-4			
24 pz.			
40885-4			
24 pz.			
40850			
48 pz.			

60	80	100	120
100.60.88			
16 m			
40895-4			
24 pz.			
100.80.88			
16 m			
40894-4			
24 pz.			
40894-4			
24 pz.			
100.100.88			
8 m			
40894-4			
24 pz.			
40895-4			
24 pz.			
40850			
48 pz.			

Continua alla pagina successiva 

Elementi di montaggio in U60X

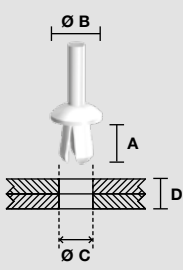
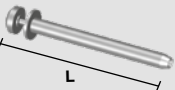
		Naturale	
 <p>Rivetti di fissaggio</p>	<p>A = 6 mm Ø B = 6 mm Ø C = 3,0-3,25 mm D = 1-3 mm</p>	1303 (1)	5.000 pz.
	<p>A = 8 mm Ø B = 11 mm Ø C = 5,1-5,25 mm D = 2-5 mm</p>	1305	1.000 pz.
	<p>A = 12 mm Ø B = 11 mm Ø C = 6,1-6,5 mm D = 5-9 mm</p>	1309	1.000 pz.
	<p>A = 21 mm Ø B = 11 mm Ø C = 6,1-6,5 mm D = 10-18 mm</p>	1318	1.000 pz.
	<p>Applicazione rivetti di fissaggio 1305, 1309 e 1318.</p> <p>L = 225 mm</p>	1300	1 pz.
 <p>Applicatore di rivetti</p>	<p>Applicazione rivetti di fissaggio rif. 1303.</p> <p>L = 120 mm</p>	1301	1 pz.

(1) Per fissare etichette. Non utilizzare per fissare canali.

Utensile

 <p>Utensile per il taglio del canale (1) Per tagliare il canale.</p>	40902
	1 pz.

(1) Tagli a 90° per canali di larghezza ≤ 60 mm. Tagli a 45° per canali di larghezza ≤ 40 mm.

Dimensioni (mm)

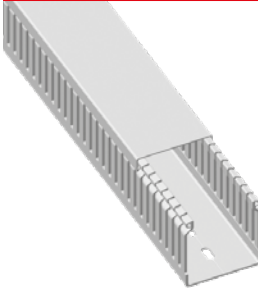
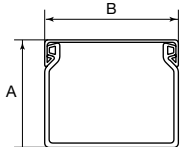
 <p>Lunghezza: 2 m</p>		Art.	Dimensioni mm.		Tipo perforazione dal fondo	Imb.
		RAL 7035	A	B		m
		25.20.88	25	20	1	60
		30.30.88	33	30	1	60
		40.20.88	42	20	1	72
		40.30.88	42	30	1	48
		40.40.88	42	43	1	32
		40.60.88	42	60	1	24
		60.30.88	60	30	1	36
		60.40.88	60	43	1	32
		60.60.88	60	60	1	32
		60.80.88	60	80	2	32
		60.120.88	60	120	2	12
		80.30.88	80	30	1	28
		80.40.88	80	43	1	24
		80.60.88	80	60	1	24
		80.80.88	80	80	2	24
		80.100.88	80	100	2	12
		80.120.88	80	120	2	12
		100.40.88	100	43	1	16
		100.60.88	100	60	1	16
		100.80.88	100	80	2	16
		100.100.88	100	100	2	8

Materiale: U43X

Perforazione del fondo compatibile con EN 50085-2-3

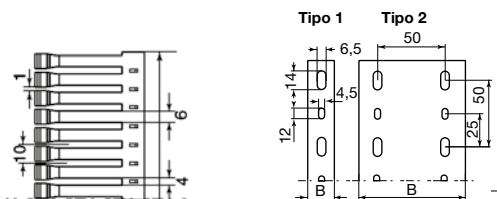

Continua alla pagina successiva →



Sezioni utili (mm²)

Capacità consigliata

Dimensioni (mm)		25x20	33x30	40x20	42x30	42x43	42x60
Articoli	Grigio RAL 7035	25.20.88	30.30.88	40.20.88	40.30.88	40.40.88	40.60.88
		 322	 728	 586	 940	 1460	 2112
Cavi V250 Numero di cavi (Fattore di riempimento 1,5)*	0,5 mm ²	53	116	96	154	237	346
	0,75 mm ²	35	77	63	102	157	229
Cavi H05/07 V-K Numero di cavi (Fattore di riempimento 1,5)*	1 mm ²	23	50	41	66	102	150
	1,5 mm ²	17	37	30	49	75	110
	2,5 mm ²	12	26	21	34	52	76

Dimensioni (mm)		60x30	60x43	60x60	60x80	60x120
Articoli	Grigio RAL 7035	60.30.88	60.40.88	60.60.88	60.80.88	60.120.88
		 1387	 2137	 3092	 4225	 6380
Cavi H05/07 V-K Numero di cavi (Fattore di riempimento 1,5)*	1 mm ²	98	150	219	299	450
	1,5 mm ²	72	111	161	220	331
	2,5 mm ²	50	77	112	153	230
	4 mm ²	40	61	89	122	184
	6 mm ²	23	35	51	70	106

Dimensioni (mm)		80x30	80x43	80x60	80x80	80x100	80x120
Articoli	Grigio RAL 7035	80.30.88	80.40.88	80.60.88	80.80.88	80.100.88	80.120.88
		 1865	 2874	 4128	 5630	 7177	 8572
Cavi H05/07 V-K Numero di cavi (Fattore di riempimento 1,5)*	1 mm ²	132	203	291	399	504	606
	1,5 mm ²	97	149	215	293	371	446
	2,5 mm ²	68	104	149	204	258	309
	4 mm ²	54	83	118	162	206	247
	6 mm ²	31	47	68	92	118	142





* Nota: per calcoli di altre sezioni o varie sezioni contemporaneamente, la sezione necessaria sarà la somma dei risultati ottenuti applicando la formula seguente ad ogni tipo di cavo: Sezione necessaria = sezione occupata dal cavo x numero cavi x 1,5.

88

U43X

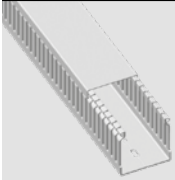
Grigio

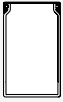
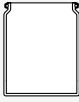
Canali
senza alogeni

Dimensioni (mm)		100x43	100x60	100x80	100x100
Articoli	Grigio RAL 7035	100.40.88	100.60.88	100.80.88	100.100.88
		 3585	 5179	 7110	 9000
Cavi H05/07 V-K Numero di cavi (Fattore di riempimento 1,5)*	1 mm ²	253	366	502	633
	1,5 mm ²	186	271	369	465
	2,5 mm ²	129	188	257	324
	4 mm ²	103	149	204	258
	6 mm ²	59	85	117	148

* Nota: per calcoli di altre sezioni o varie sezioni contemporaneamente, la sezione necessaria sarà la somma dei risultati ottenuti applicando la formula seguente ad ogni tipo di cavo: Sezione necessaria = sezione occupata dal cavo x numero cavi x 1,5.

